

REV.	EQN NO	LOCATIONS	DESCRIPTION	DATE	REVISER	APPD

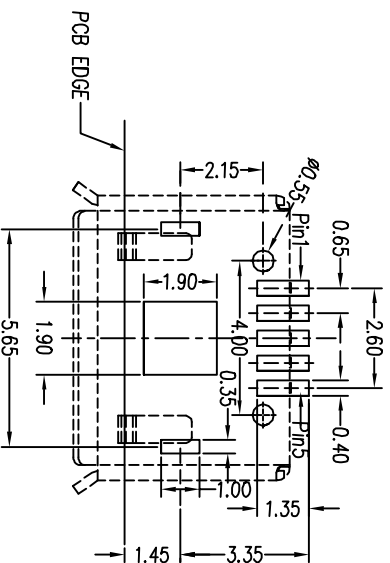
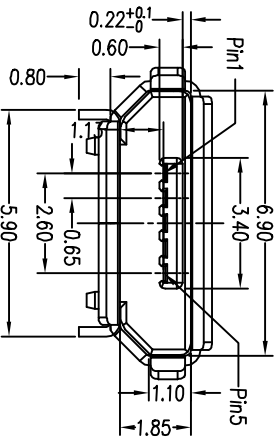
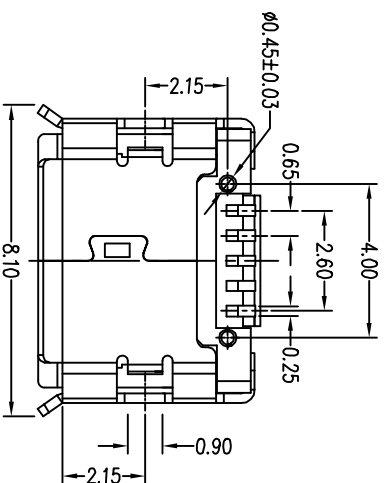
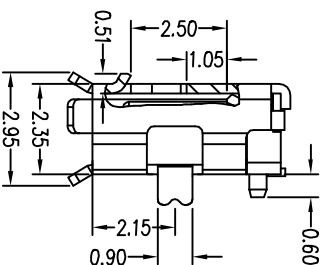
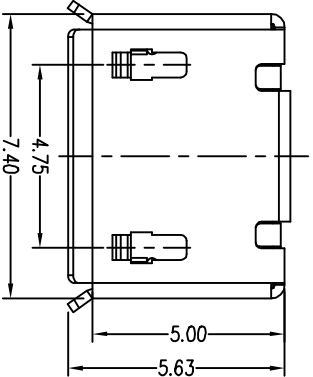
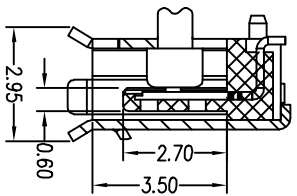
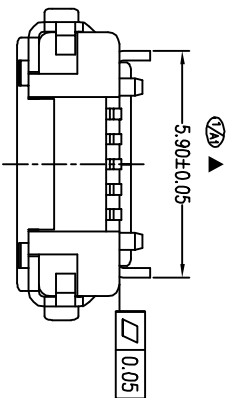

RECOMMENDED PCB LAYOUT

Note:

1. Material:
 - 1.1 Housing: High temperature thermoplastic with g.f.i.U.L.94V-0
 - 1.2 Contact: copper alloy,t=0.20mm
 - 1.3 Shell: copper alloy,t=0.25mm
2. Specification:
 - 2.1 Current rating: 1 A Max.
 - 2.2 Dielectric withstanding voltage: 100 V(ac) for 1 min.
 - 2.3 Contact resistance: 50 mΩ Max.
 - 2.4 Insulation resistance: 100 MΩ Min.
 - 2.5 Total mating force: 3.57 Kgf Max.
 - 2.6 Total unmating force: 1.0 Kgf Min.0.81~2.05 Kgf Min.after 10000 insertion/extraction cycles
 - 2.7 Temperature range: -30°C~80°C

Order Information:

1-MD055MXXX-01
 ① ② ③ ④ ⑤ ⑥ ⑦ ⑧ ⑨

- | | | | |
|----------------|-----------|--------------------|------------------|
| 1: Assy. | 5: Style | 7: Contact plating | 8: Shell plating |
| 2: Series No. | M: Smt | 1: 1u" | T: Tin |
| 3: Contact No. | 6: Color | 2: 3u" | N: Nickel |
| 05: 5 pos. | B: Black | 3: 5u" | A: Au plated all |
| 4: P: Plug | W: White | 4: 15u" | B: None |
| S: Socket | N: Nature | 5: 30u" | ... |

No.	Nome	Q'ty	Finish
3	Shell	1	N/A
2	Contact	5	N/A
1	Housing	1	N/A

PART NO: 1-MD055MXXX-01		MATERIAL: SEE NOTE	
MODEL NO:		FINSH: SEE NOTE	
UNIT: mm	SIZE: A4	COLOR: SEE NOTE	
TOLERANCE UNSPECIFIED			
.x	±0.38	DR:	
.xx	±0.25	CHK:	
.xxx	±0.13	APP:	
ANG.	±2°	SCALE: 1:1	

深圳扬讯电子有限公司
 TITLE: MICRO USB 5S B Type Smt 插板(5.9)
 CUSTOMER DRAWING
 DWG NO: A055
 REV: A

SCALE: 1:1	SHEET: 1/1	REV: A
------------	------------	--------