

MODEL: 6N4-2A-5

NO.:301020003-00023

Unit:mm Terminal type:

(+) 140mmCB104 (-)140mmLA106

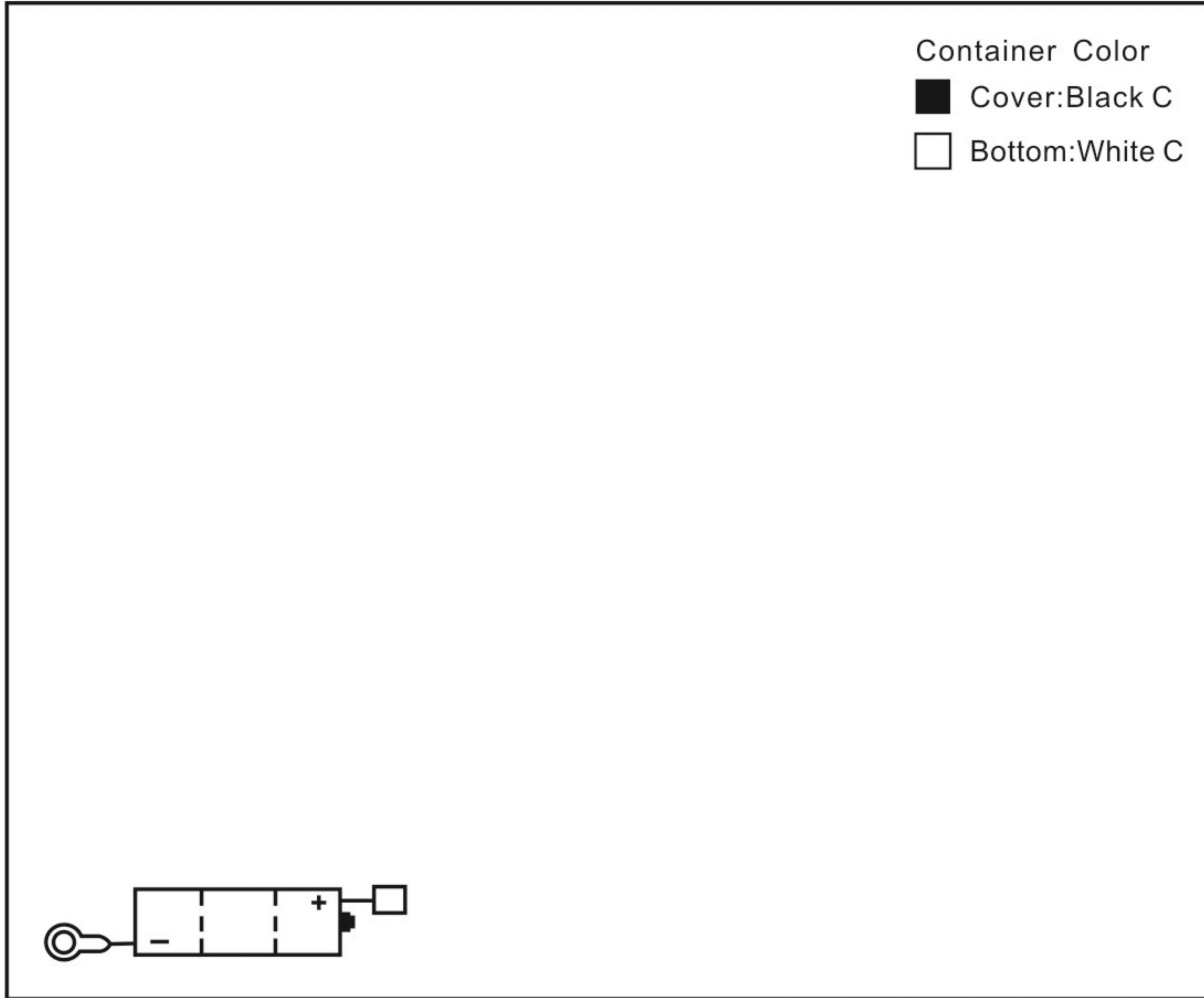

Plane Chart:

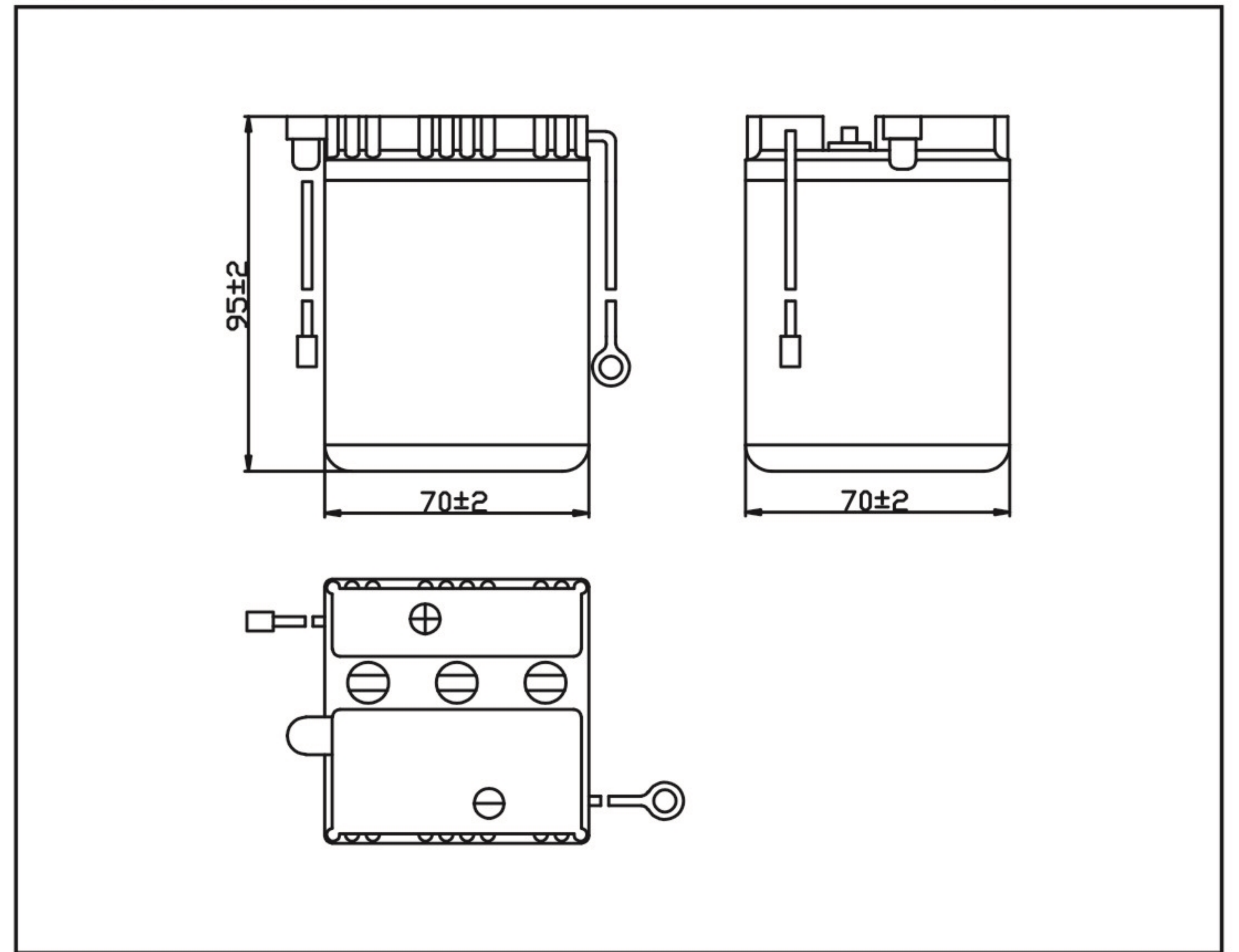

Parts:

Executed Standard:JISD 5302-2004

Cover	Container Bottom	Terminal	Positive Plate	Negative Plate	Separator	Electrolyte	Safety Valve	Explosion Plate	Way of Sealing
PP	PP	Pb	PbO ₂	Pb	PE/Compound Fibre	dilute sulphuric acid	Rubber	PP	Heat Sealing

Parameter Chart:

Volts	6V		
Capacity (25°C)	10 hours rate		4Ah
Appx.Dimension (mm)	L±2		70
	W±2		70
	H±2		95
Storage Status	Dry		
Weight (Approx)	0.49Kg	Weight w/ Acid	0.26Kg
Retention of Charge Storage @25°C			
1 month	97%	Directly Mounted	
3 month	90%	Directly Mounted	
6 month	80%	Constant Volts:7.2V Limit Current:0.8A Charging Hours:2-3H	
12 month	40%	Constant Volts:7.2V Limit Current:0.8A Charging Hours:4-6H	
CCA	Factory Standard (-10°C)	Factory Standard (-18°C)	
Discharging Current	-	-	

Discharge Current 25°C

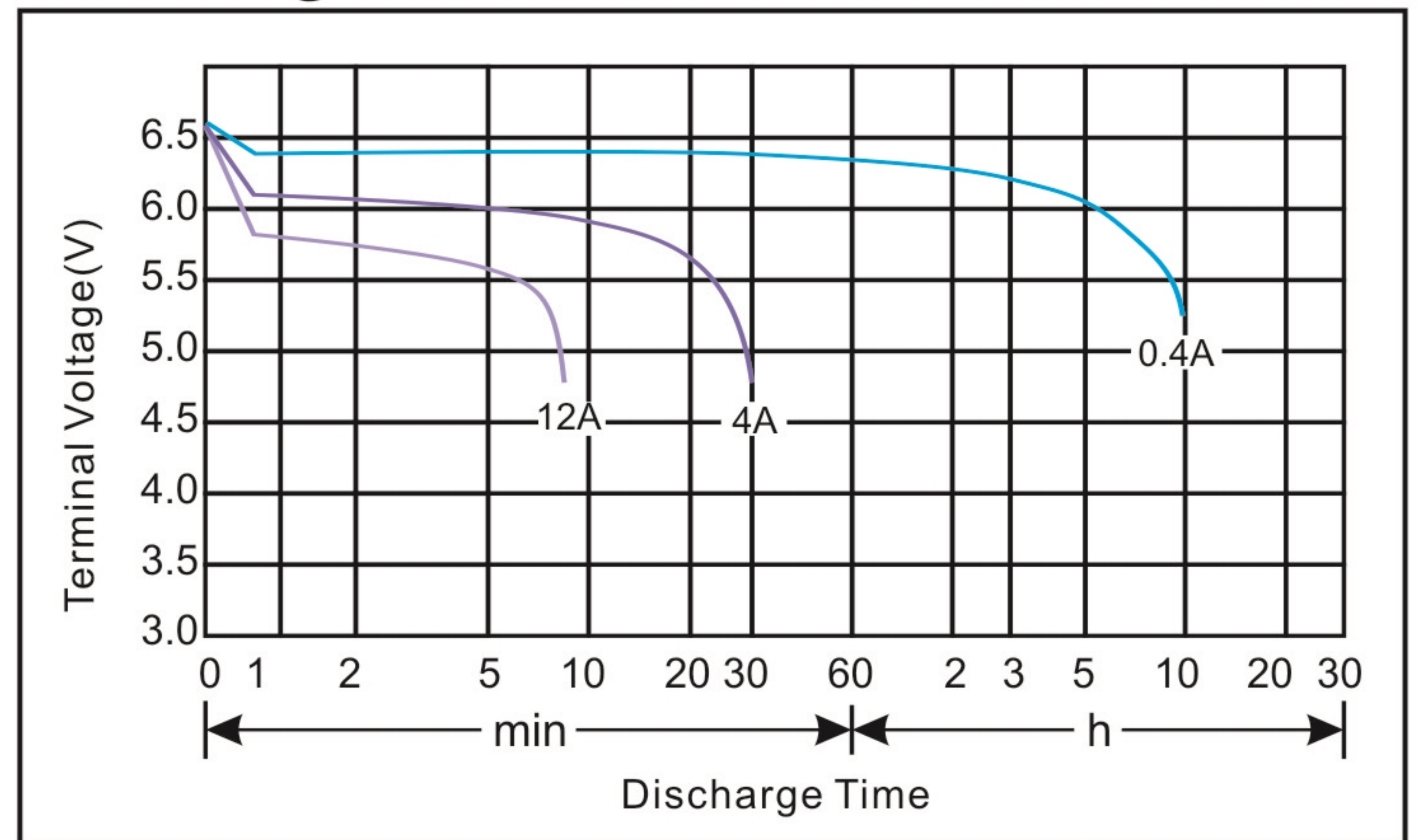

Residual Capacity

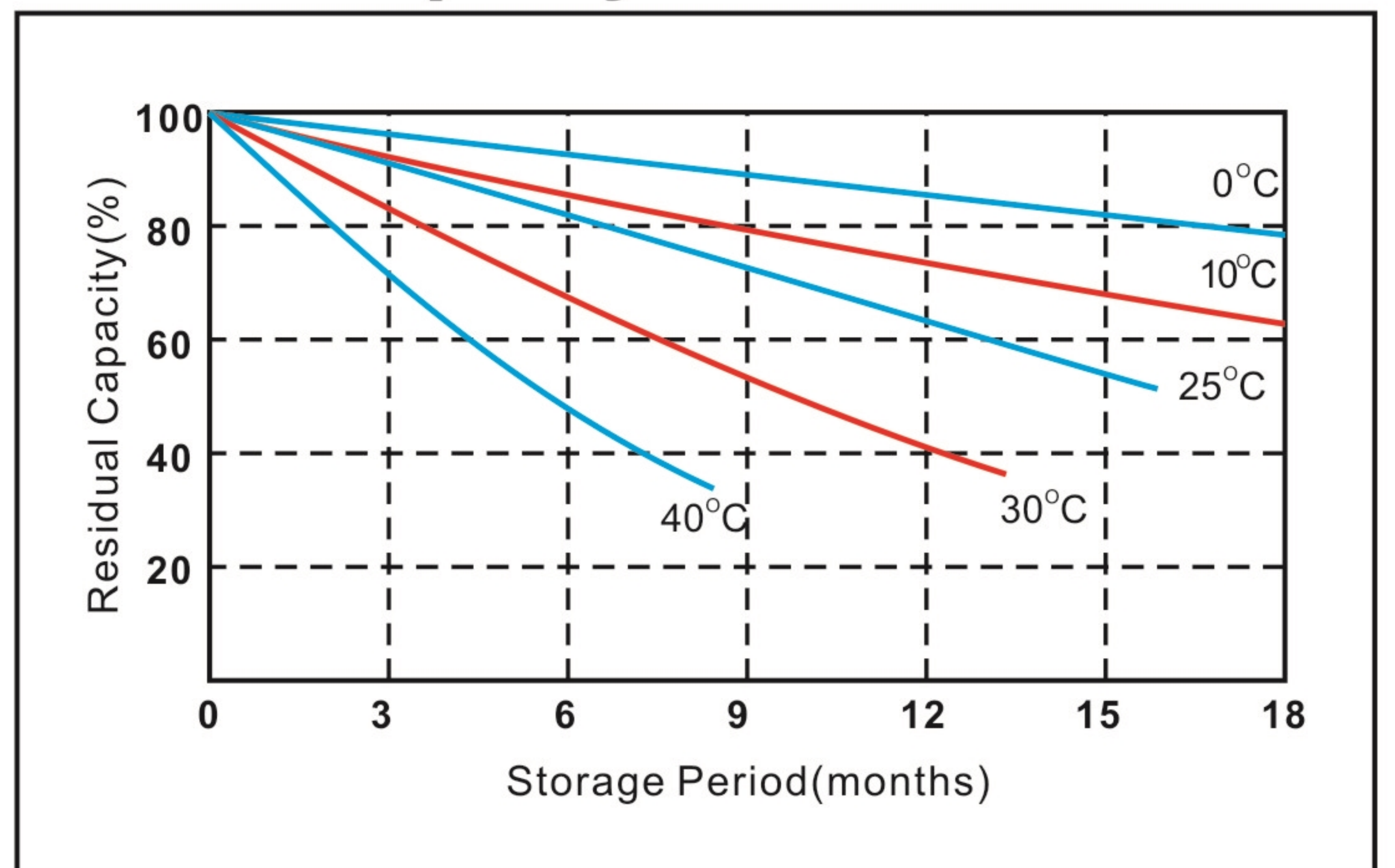

★The above are average and data obtained from the first 3 charge/discharge cycles. These are not minimum values.

★The different item No. of battery can be developed according to the customer's demand.