



# DEAN

1 Color | 2 Sizes | 1 Finish



White

**COLOR**

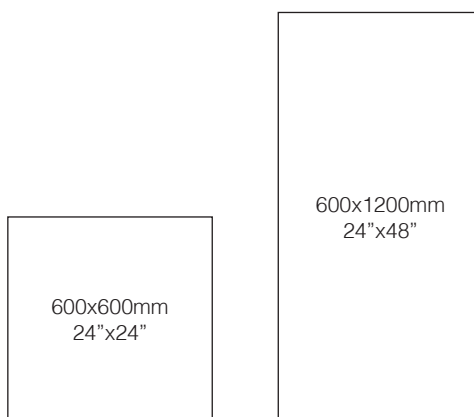

**SIZES**

<b>SIZE:</b>	<b>600x600mm/24"x24"</b>	<b>600x1200mm/24"x48"</b>
<b>SURFACE:</b>	<b>Soft + Shaped</b>	<b>Soft + Shaped</b>
White	MER6964	MER12964



## PACKING

Weight shown here may slightly vary depending on the production









Size Formate	Thickness Espesor	Box Caja				Pallet Paleta				Container/20' 24000Kg	Container/20' 27000Kg
cm	mm	pieces	m <sup>2</sup>	kg		boxes	m <sup>2</sup>	kg		m <sup>2</sup> / sq.m	m <sup>2</sup> / sq.m
60x60	9,5	4	1.44	30		40	57.6	1220		1127.52	1271.52
80x80	10	3	1.92	45		32	61.44	1460		1002.24	1130.88
60x120	11	2	1.44	35		56	80.64	1980		974.88	1097.28
inch	inch	units	ft <sup>2</sup>	lb		boxes	ft <sup>2</sup>	lb		ft <sup>2</sup>	ft <sup>2</sup>
23 5/8 x 23 5/8	3/8	4	15.50	66.14		40	620.00	2689.64		12136.52	13686.53
31 1/2 x 31 1/2	3/8	3	20.67	99.21		32	661.33	3218.75		10788.02	12172.69
23 5/8 x 47 1/4	7/16	2	15.50	77.16		56	868.00	4365.15		10493.52	11811.02

## TECHNICAL FEATURES

This chart is for tiles with water absorption less than 0.5%, which is classified as impervious

Technical features	Standard	Standard requirement	Average value
Length and width		± 0.6%	± 0.3%
Thickness		± 5%	± 2%
 Straightness of sides	ISO 10545-2	± 0.5%	± 0.2%
Rectangularity		± 0.5%	± 0.2%
Surface flatness		± 0.5%	± 0.2%
 Water absorption	ISO 10545-3	≤0.5%	≤0.1%
Breaking strength		≥1300n	≥1500n
 Modulus of rupture	ISO 10545-4	≥35N/mm <sup>2</sup>	≥39N/mm <sup>2</sup>
 Abrasion resistance	ISO 10545-6	≤175 mm <sup>2</sup>	Class 4
 Chemical resistance	ISO 10545-13	min class B	GLA
 Frost resistance	ISO 10545-12	required	Resistant
 Stain resistance	ISO 10545-14	min Class 3	Class 5
 Thermal shock resistance	ISO 10545-9	test method available	Resistant

This chart is for tiles with water absorption between 0.5% and 3%, which is classified as vitreous

Technical features	Standard	Standard requirement	Average value
Length and width		$\pm 0.6\%$	$\pm 0.3\%$
Thickness		$\pm 5\%$	$\pm 2\%$
 Straightness of sides	GB/T 3810.2	$\pm 0.5\%$	$\pm 0.3\%$
Rectangularity		$\pm 0.5\%$	$\pm 0.3\%$
Surface flatness		$\pm 0.5\%$	$\pm 0.3\%$
 Water absorption	GB/T 3810.3	$0.5\% < E \leq 3\%$	$E < 1.8\%$
 Breaking strength	GB/T 3810.4	$\geq 1100n$	$\geq 1500n$
Modulus of rupture		$\geq 30N/mm^2$	$\geq 35N/mm^2$
 Abrasion resistance	GB/T 3810.6	$\leq 175 mm^2$	Class 4
 Chemical resistance	GB/T 3810.13	indicated by the manufacturer	GLA
 Frost resistance	GB/T 3810.12	required	Resistant
 Stain resistance	GB/T 3810.14	min Class 3	Class 5
 Thermal shock resistance	GB/T 3810.9	test method available	Resistant



Made in China

MITO Ceramics belongs to Meiyitao (Fujian) High-tech Construction Materials Co., Ltd  
[www.mitoceramics.com](http://www.mitoceramics.com) | [hello@mitoceramics.com](mailto:hello@mitoceramics.com) | +86 13615963688

