



Matte + Shaped



EATON

1 Color | 2 Sizes | 1 Finish



Beige

COLOR

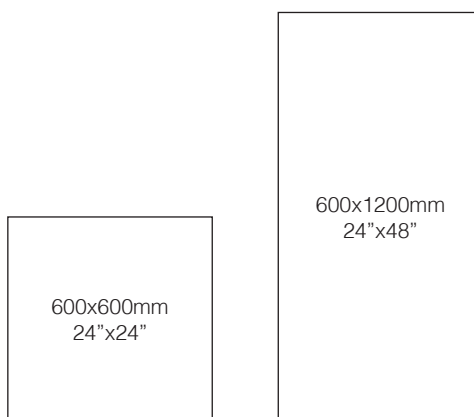

SIZES

| | | |
|-----------------|--------------------------|---------------------------|
| SIZE: | 600x600mm/24"x24" | 600x1200mm/24"x48" |
| SURFACE: | Soft + Shaped | Soft + Shaped |
| Beige | CM9663 | CM129663 |









PACKING

Weight shown here may slightly vary depending on the production









| Size Formate | Thickness Espesor | Box Caja | | | Pallet Paleta | | | Container/20' 24000Kg | Container/20' 27000Kg |
|-----------------|----------------------|-------------|-----------------|-------|------------------|-----------------|---------|--------------------------|--------------------------|
| cm | mm | pieces | m ² | kg | boxes | m ² | kg | m ² / sq.m | m ² / sq.m |
| 60x60 | 9,5 | 4 | 1.44 | 30 | 40 | 57.6 | 1220 | 1127.52 | 1271.52 |
| 80x80 | 10 | 3 | 1.92 | 45 | 32 | 61.44 | 1460 | 1002.24 | 1130.88 |
| 60x120 | 11 | 2 | 1.44 | 35 | 56 | 80.64 | 1980 | 974.88 | 1097.28 |
| inch | inch | units | ft ² | lb | boxes | ft ² | lb | ft ² | ft ² |
| 23 5/8 x 23 5/8 | 3/8 | 4 | 15.50 | 66.14 | 40 | 620.00 | 2689.64 | 12136.52 | 13686.53 |
| 31 1/2 x 31 1/2 | 3/8 | 3 | 20.67 | 99.21 | 32 | 661.33 | 3218.75 | 10788.02 | 12172.69 |
| 23 5/8 x 47 1/4 | 7/16 | 2 | 15.50 | 77.16 | 56 | 868.00 | 4365.15 | 10493.52 | 11811.02 |

TECHNICAL FEATURES

This chart is for tiles with water absorption less than 0.5%, which is classified as impervious

| Technical features | Standard | Standard requirement | Average value |
|--|--------------|-----------------------|----------------------|
| Length and width | | ± 0.6% | ± 0.3% |
| Thickness | | ± 5% | ± 2% |
|  Straightness of sides | ISO 10545-2 | ± 0.5% | ± 0.2% |
| Rectangularity | | ± 0.5% | ± 0.2% |
| Surface flatness | | ± 0.5% | ± 0.2% |
|  Water absorption | ISO 10545-3 | ≤0.5% | ≤0.1% |
| Breaking strength | | ≥1300n | ≥1500n |
|  Modulus of rupture | ISO 10545-4 | ≥35N/mm ² | ≥39N/mm ² |
|  Abrasion resistance | ISO 10545-6 | ≤175 mm ² | Class 4 |
|  Chemical resistance | ISO 10545-13 | min class B | GLA |
|  Frost resistance | ISO 10545-12 | required | Resistant |
|  Stain resistance | ISO 10545-14 | min Class 3 | Class 5 |
|  Thermal shock resistance | ISO 10545-9 | test method available | Resistant |

This chart is for tiles with water absorption between 0.5% and 3%, which is classified as vitreous

| Technical features | Standard | Standard requirement | Average value |
|--|--------------|-------------------------------|-----------------|
| Length and width | | $\pm 0.6\%$ | $\pm 0.3\%$ |
| Thickness | | $\pm 5\%$ | $\pm 2\%$ |
|  Straightness of sides | GB/T 3810.2 | $\pm 0.5\%$ | $\pm 0.3\%$ |
| Rectangularity | | $\pm 0.5\%$ | $\pm 0.3\%$ |
| Surface flatness | | $\pm 0.5\%$ | $\pm 0.3\%$ |
|  Water absorption | GB/T 3810.3 | $0.5\% < E \leq 3\%$ | $E < 1.8\%$ |
|  Breaking strength | GB/T 3810.4 | $\geq 1100n$ | $\geq 1500n$ |
| Modulus of rupture | | $\geq 30N/mm^2$ | $\geq 35N/mm^2$ |
|  Abrasion resistance | GB/T 3810.6 | $\leq 175 mm^2$ | Class 4 |
|  Chemical resistance | GB/T 3810.13 | indicated by the manufacturer | GLA |
|  Frost resistance | GB/T 3810.12 | required | Resistant |
|  Stain resistance | GB/T 3810.14 | min Class 3 | Class 5 |
|  Thermal shock resistance | GB/T 3810.9 | test method available | Resistant |



Made in China

MITO Ceramics belongs to Meiyitao (Fujian) High-tech Construction Materials Co., Ltd
www.mitoceramics.com | hello@mitoceramics.com | +86 13615963688

