

PRODUCT SPECIFICATION

Model No.: FYLS-3014UWC56-0.1W

Features:
<ul style="list-style-type: none"> ■ SMD Type ■ Size (mm):3.00*1.40*0.70 ■ Emitting Color: White. ■ Lens Color: Yellow Diffused. ■ SMT package ■ Suitable for all SMT assembly and soldering method ■ Pb-free Reflow soldering application ■ RoHS Compliant ■ SIDE LED ■ MSL:6

Applications:
<ul style="list-style-type: none"> ■ Light Strips ■ LCD Backlight ■ Decorative lighting ■ Indicators ■ Interior automotive ■ Illuminations ■ Mobile Phones



CUSTOMER APPROVED SIGNATURES	APPROVED BY	CHECKED BY	PREPARED BY

NINGBO FORYARD OPTOELECTRONICS CO.,LTD.

Add:No. 666 Jinghua Road, Hi-tech Park, Ningbo, Zhejiang, China

Zip:315103

Tel: 0086-574-87933652 87927870 87922206

Fax: 0086-574-87927917

E-mail:Sales@foryard.com (General)

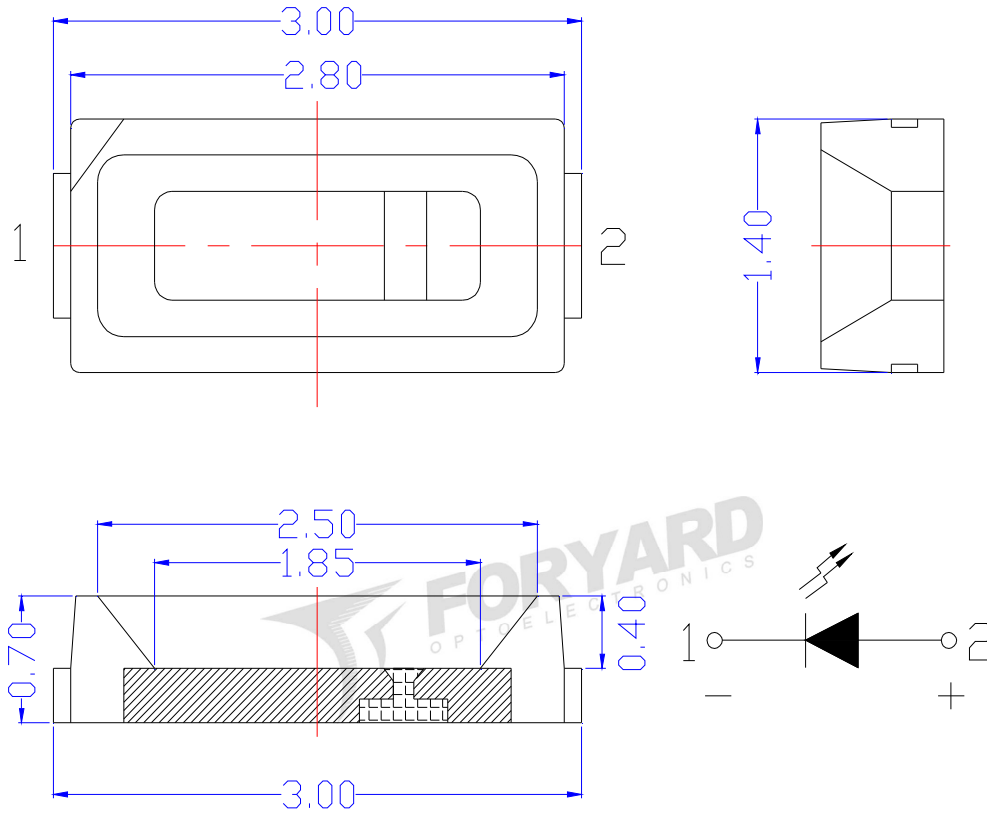
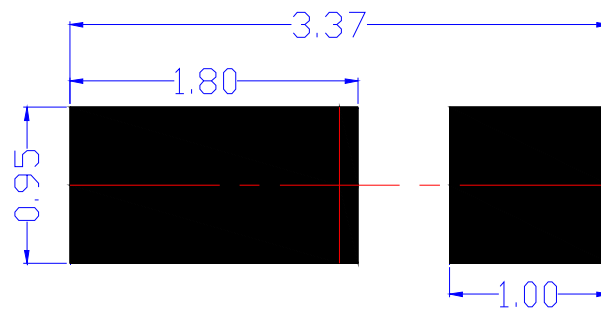
Model No.: FYLS-3014UWC56-0.1W
■ Mechanical Dimensions

■ Recommend Soldering pad design(unit=mm)

Notes:

1. Dimension in millimeter, tolerance is ± 0.10 .
2. Angle: $\pm 5^\circ$
3. The specifications, characteristics and technical data described in the datasheet are subject to change without prior notice.
4. The drawing is different from the actual one, please refer to the sample.

Model No.: FYLS-3014UWC56-0.1W

Absolute Maximum Ratings(Ta=25°C)

Parameter	Symbol	MAX.	Unit
Power Dissipation	PD	200	mW
Peak Forward Current*	IFP	100	mA
Continuous Forward Current	IF	30	mA
Reverse Voltage	VR	5	V
Operating Temperature Range	Topr	-40~ +85	°C
Storage Temperature Range	Tstg	-40~ +85	°C

*1/10 Duty Cycle, 0.1ms Pulse Width

Typical Electrical & Optical Characteristics(Ta=25°C)

Parameter	Symbol	Test Condition	Min.	Typ.	Max.	Unit
Forward Voltage	V _F	IF=30mA	2.8	3	3.4	V
Reverse Current	I _R	VR=5V	---	---	10	μA
Chromaticity coordinates	X	IF=30mA	---	0.3	---	---
	Y	IF=30mA	---	0.29	---	---
Color temperature	CCT	IF=30mA	4500	---	7000	K
Color rendering index	Ra	IF=30mA	70	---	80	Ra
Luminous Intensity	I _v	IF=30mA	10	13	16	Lm
Viewing Angle	2θ _{1/2}	IF=30mA	---	120	---	Deg

Material

Item	Reflector	Wire	Encapsulate	Chip
Material	PPA	Gold	Silicone	InGaN/GaN

Note:

- 1.Luminous Intensity is based on the Foryard standards.
- 2.Pay attention about static for InGaN

The Luminous Intensity Grade of Products(Unit: mcd) ;Test Condition: If=30mA,Ta=25°C

Code	B08	B09	B10	B11	B12	B13
Luminous Intensity(Lm)	10~11	11~12	12~13	13~14	14~15	15~16

Tolerance of measurement of luminous intensity is ±15%

Forward Voltage Grade of Products (Unit: V); Test Condition: If=30mA,Ta=25°C

Code	7	8	9
Forward Voltage(V)	2.8~3.0	3.0~3.2	3.2~3.4

Tolerance of measurement of forward voltage is ±0.1V

Model No.: FYLS-3014UWC56-0.1W

Chromaticity Coordinate Grade of White Chip-LED Products

Test Condition:@IF=30mA Ta=25°C

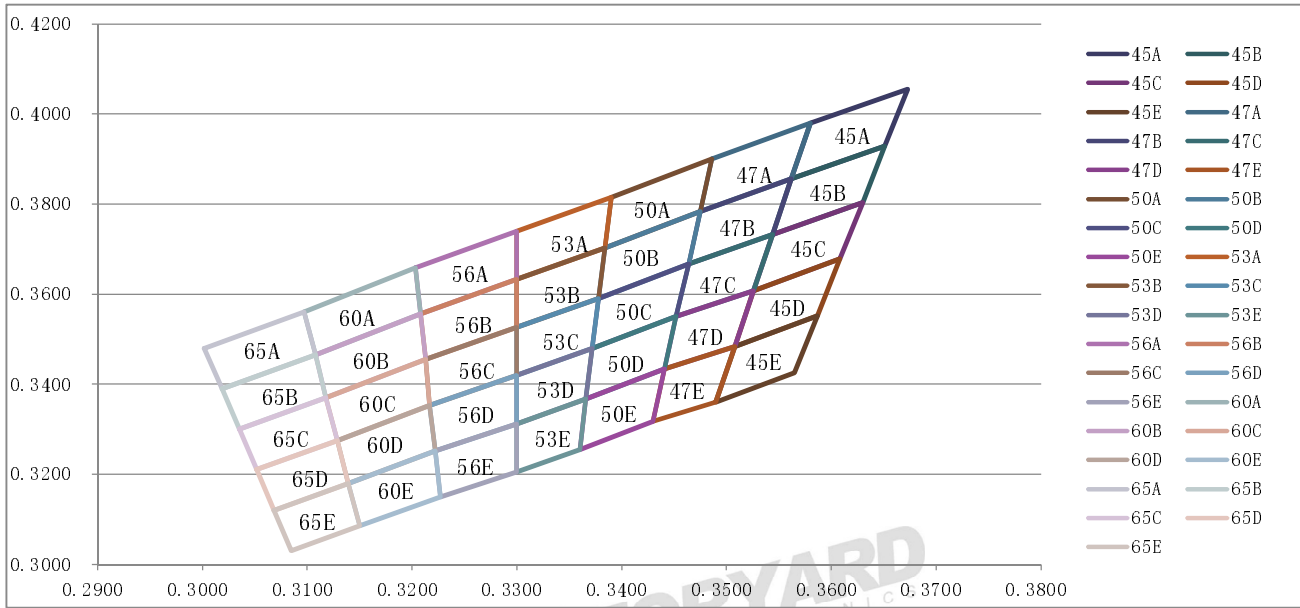

BIN	CIE	Top	Right	Bottom	Left	BIN	CIE	Top	Right	Bottom	Left
4500-4750K						4750-5000K					
45A	X	0.3580	0.3673	0.3651	0.3562	47A	X	0.3486	0.3580	0.3562	0.3475
	Y	0.3980	0.4055	0.3929	0.3856		Y	0.3900	0.3980	0.3856	0.3784
45B	X	0.3562	0.3651	0.3630	0.3544	47B	X	0.3475	0.3562	0.3544	0.3464
	Y	0.3856	0.3929	0.3803	0.3732		Y	0.3784	0.3856	0.3732	0.3667
45C	X	0.3544	0.3630	0.3608	0.3526	47C	X	0.3464	0.3544	0.3526	0.3452
	Y	0.3732	0.3803	0.3678	0.3608		Y	0.3667	0.3732	0.3608	0.3551
45D	X	0.3526	0.3608	0.3587	0.3508	47D	X	0.3452	0.3526	0.3508	0.3441
	Y	0.3608	0.3678	0.3552	0.3484		Y	0.3551	0.3608	0.3484	0.3434
45E	X	0.3508	0.3587	0.3565	0.3490	47E	X	0.3441	0.3508	0.3490	0.3430
	Y	0.3484	0.3552	0.3426	0.3360		Y	0.3434	0.3484	0.3360	0.3318
5000-5300K						5300-5600K					
50A	X	0.3390	0.3486	0.3475	0.3384	53A	X	0.3300	0.3390	0.3384	0.3300
	Y	0.3815	0.3900	0.3784	0.3703		Y	0.3740	0.3815	0.3703	0.3633
50B	X	0.3384	0.3475	0.3464	0.3378	53B	X	0.3300	0.3384	0.3378	0.3300
	Y	0.3703	0.3784	0.3667	0.3591		Y	0.3633	0.3703	0.3591	0.3526
50C	X	0.3378	0.3464	0.3452	0.3372	53C	X	0.3300	0.3378	0.3372	0.3300
	Y	0.3591	0.3667	0.3551	0.3479		Y	0.3526	0.3591	0.3479	0.3419
50D	X	0.3372	0.3452	0.3441	0.3366	53D	X	0.3300	0.3372	0.3366	0.3300
	Y	0.3479	0.3551	0.3434	0.3367		Y	0.3419	0.3479	0.3367	0.3312
50E	X	0.3366	0.3441	0.3430	0.3360	53E	X	0.3300	0.3366	0.3360	0.3300
	Y	0.3367	0.3434	0.3318	0.3255		Y	0.3312	0.3367	0.3255	0.3205
5600-6000K						6000-6500K					
56A	X	0.3203	0.3300	0.3300	0.3208	60A	X	0.3097	0.3203	0.3208	0.3108
	Y	0.3658	0.3740	0.3633	0.3556		Y	0.3560	0.3658	0.3556	0.3465
56B	X	0.3208	0.3300	0.3300	0.3213	60B	X	0.3108	0.3208	0.3213	0.3118
	Y	0.3556	0.3633	0.3526	0.3455		Y	0.3465	0.3556	0.3455	0.3370
56C	X	0.3213	0.3300	0.3300	0.3217	60C	X	0.3118	0.3213	0.3217	0.3129
	Y	0.3455	0.3526	0.3419	0.3353		Y	0.3370	0.3455	0.3353	0.3275
56D	X	0.3217	0.3300	0.3300	0.3222	60D	X	0.3129	0.3217	0.3222	0.3139
	Y	0.3353	0.3419	0.3312	0.3252		Y	0.3275	0.3353	0.3252	0.3180
56E	X	0.3222	0.3300	0.3300	0.3227	60E	X	0.3139	0.3222	0.3227	0.3150
	Y	0.3252	0.3312	0.3205	0.3150		Y	0.3180	0.3252	0.3150	0.3085
6500-7000K											
65A	X	0.3002	0.3097	0.3108	0.3019	65B	X	0.3019	0.3108	0.3118	0.3035
	Y	0.3480	0.3560	0.3465	0.3390		Y	0.3390	0.3465	0.3370	0.3300
65C	X	0.3035	0.3118	0.3129	0.3052	65D	X	0.3052	0.3129	0.3139	0.3068
	Y	0.3300	0.3370	0.3275	0.3210		Y	0.3210	0.3275	0.3180	0.3120
65E	X	0.3068	0.3139	0.3150	0.3085						
	Y	0.3120	0.3180	0.3085	0.3030						

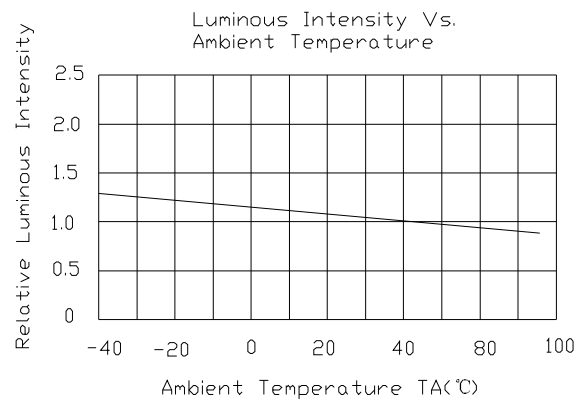
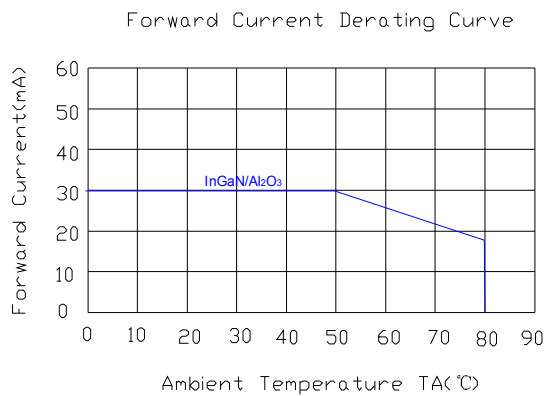
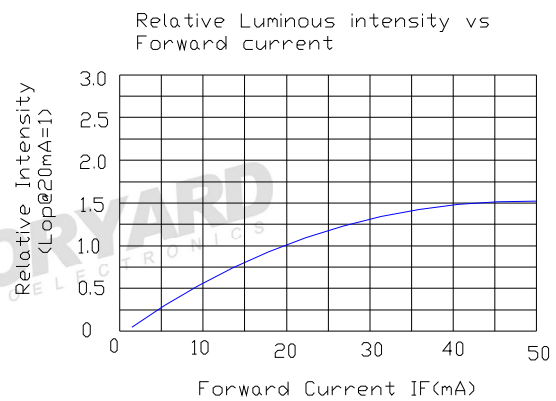
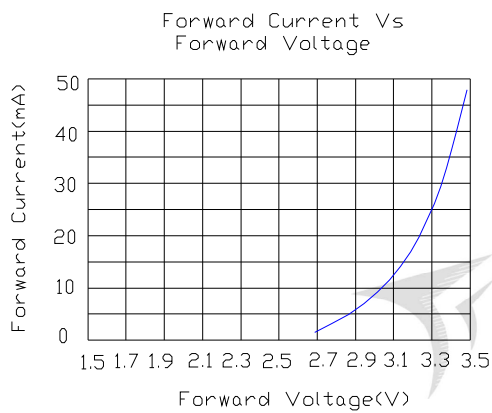
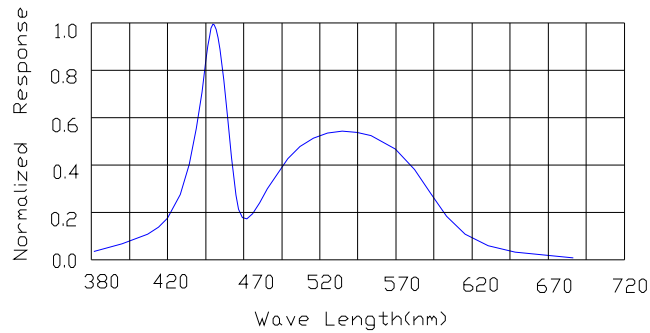
Model No.: FYLS-3014UWC56-0.1W
Electrical-Optical Characteristics-

NOTE: 25°C free air temperature unless otherwise specified

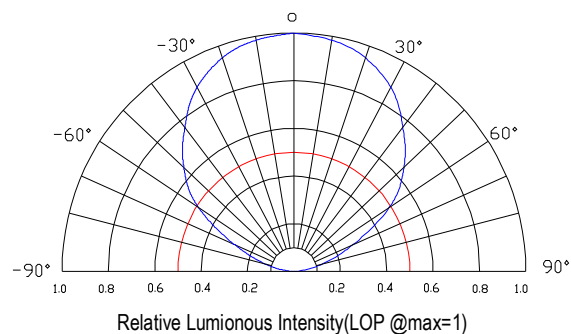
Radiation pattern-

Model No.: FYLS-3014UWC56-0.1W

■ **Package-**

1. Reel Dimension

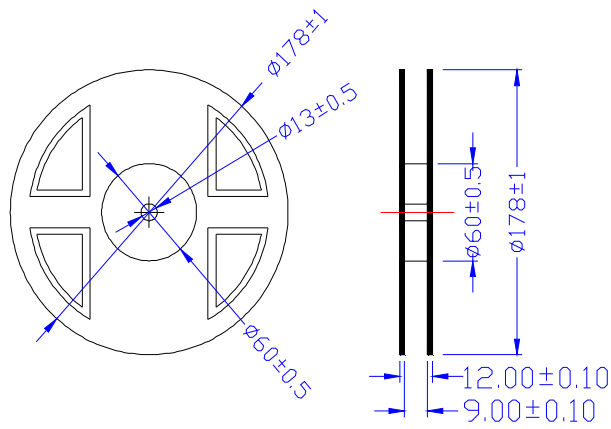

2. Tape Dimension

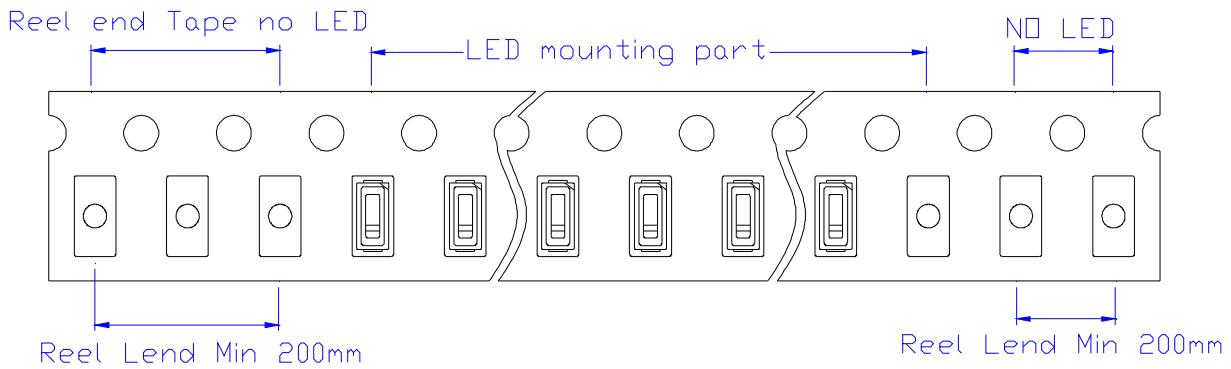
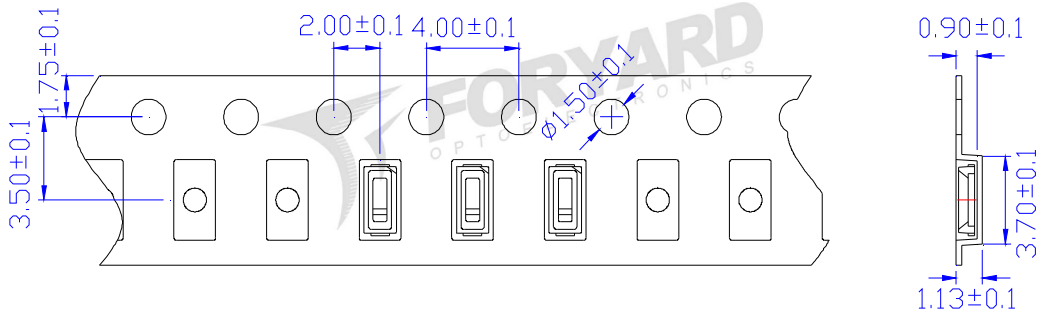

Notice:

1. Tolerance unless mentioned is $\pm 0.2\text{mm}$

Model No.:	FYLS-3014UWC56-0.1W
Date / Rev.	2020.07.29 / A

Model No.: FYLS-3014UWC56-0.1W

3. Packing Diagram

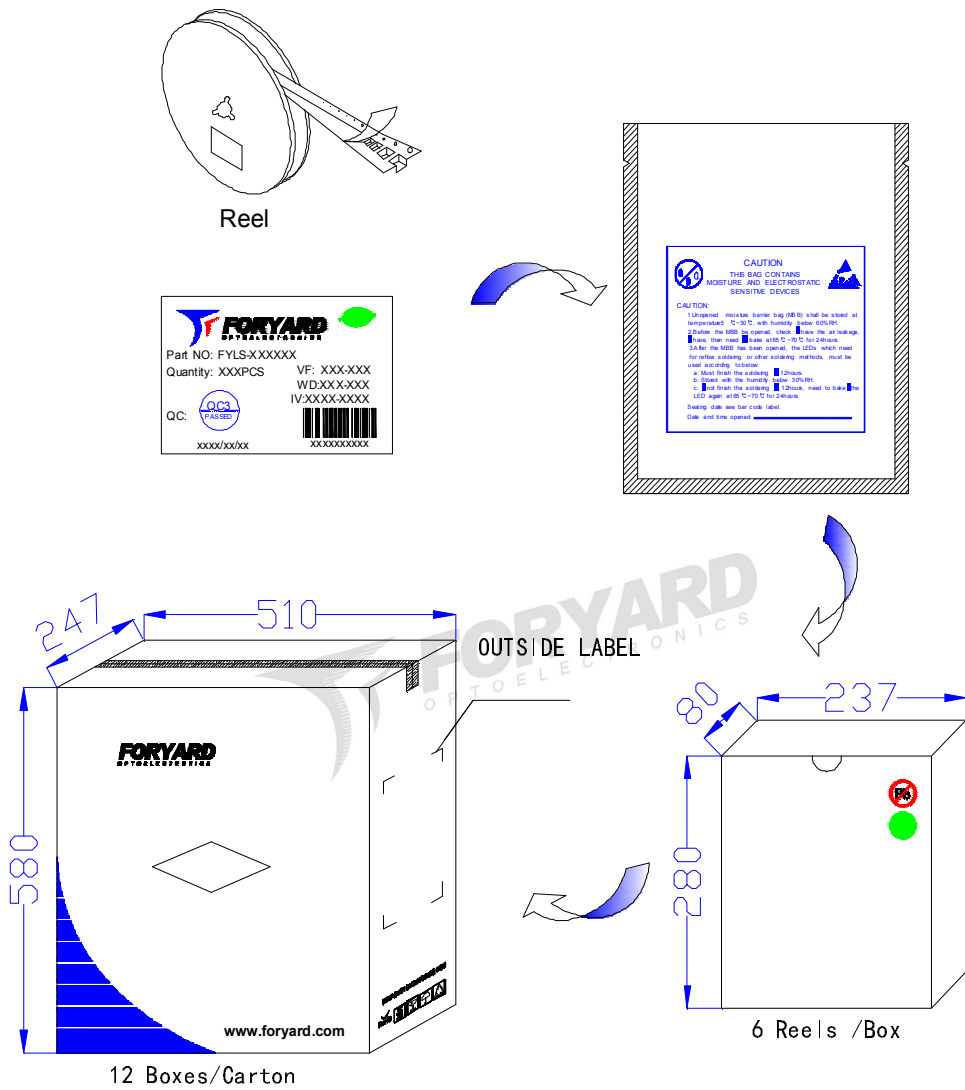

12 Boxes/Carton

6 Reels / Box



LED
 PN: FYLS-XXXXXXXXXX
 Qty: XXXXX PCS
 Date: XXXX/XX/XX
 GW: XX.XX KG
 NW: XX.XX KG



XXXXXXXXXX



OUTSIDE LABEL

Notice:

- 1.Quantity:4000 PCS/Reel
- 2.The specifications are subject to change without notice. Please contact us for updated information.

Model No.: FYLS-3014UWC56-0.1W

■ Soldering Characteristics-

● Reflow Soldering

● Lead Solder

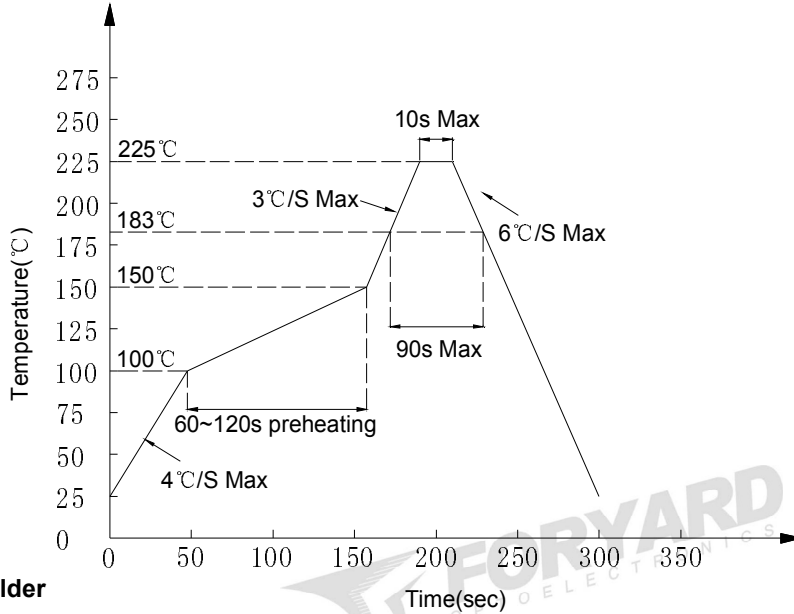

● Lead-free Solder

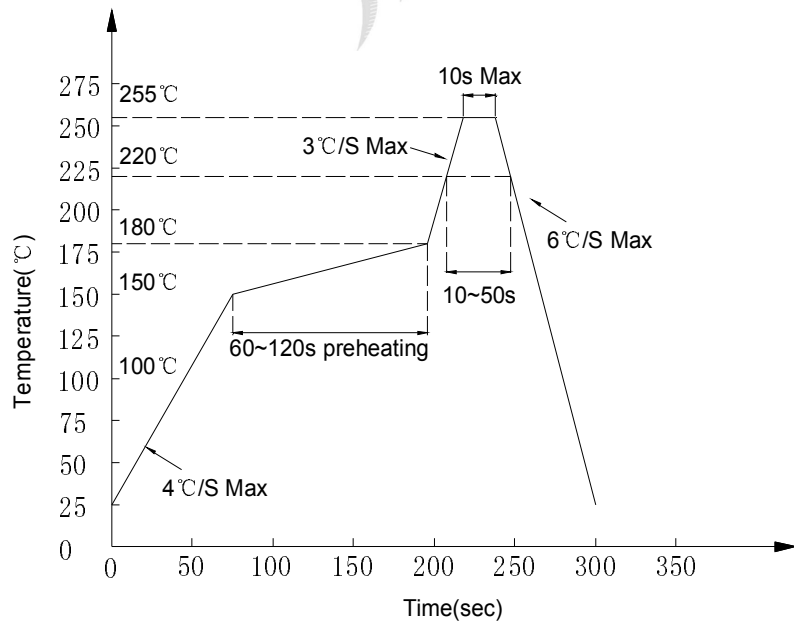

Notes:

1. Although the recommended soldering conditions are specified in above table, reflow or hand soldering at the lowest possible temperature is desired for the LEDs.
2. A rapid-rate process is not recommended for cooling the LEDs down from the peak temperature.
3. All temperatures refer to solder Pad.

● Hand Soldering

Soldering temperature	300°C Max. (25W Max.)	One time only
Soldering time	5 ±1sec	

Model No.: FYLS-3014UWC56-0.1W

■ **Handling of Silicone Resin LEDs-**

● **Handling Indications**

When handling the product, do not touch it directly with bare hands as it may contaminate the surface and affect on optical characteristics. In the worst cases, excessive force to the product might result in catastrophic failure due to package damage and/or wire breakage.

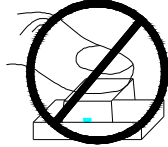

When handling the product with tweezers, LEDs should only be handled from the side and make sure that excessive force is not applied to the resin portion of the product. Failure to comply can cause the resin portion of the product to be cut, chipped, delaminated and/or deformed, and wire to be broken, and thus resulting in catastrophic failure.

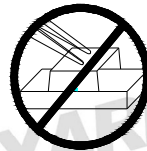
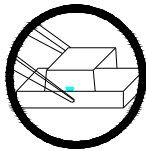

■ **Recommended circuit-**

• In designing a circuit, the current through each LED must not exceed the absolute maximum rating specified for each LED. It is recommended to use Circuit B which regulates the current flowing through each LED. In the meanwhile, when driving LED with a constant voltage in Circuit A, the current through the LEDs may vary due to the variation in forward voltage (VF) of the LEDs. In the worst case, some LED may be subjected to stresses in excess of the absolute maximum rating.

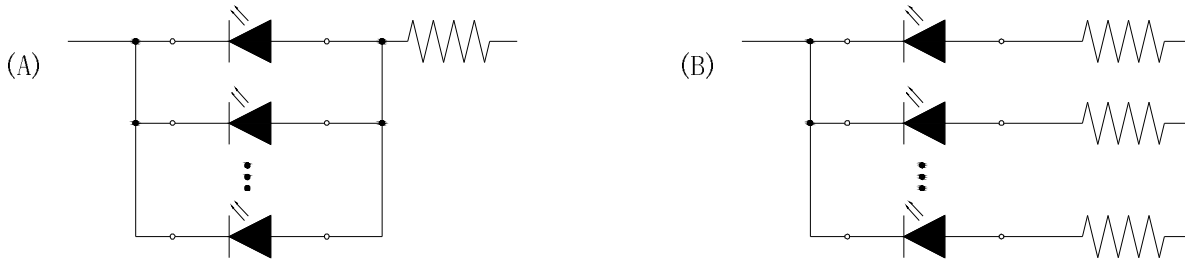

• This product should be operated in forward bias. A driving circuit must be designed so that the product is not subjected to either forward or reverse voltage while it is off. In particular, if a reverse voltage is continuously applied to the product; such operation can cause migration resulting in LED damage.

■ **Storage-**

● **Storage Conditions**

1. Unopened moisture barrier bag (MBB) shall be stored at temperature below 5°C~30°C, with humidity below 60%RH.
2. Before the MBB be opened, check if have the air leakage, if have, then need to bake at 65°C~70°C for 24hours.
3. After the MBB has been opened, the LEDs which need for reflow soldering or other soldering methods, must be used according to below:
 - a: Must finish the soldering in 12hours
 - b: Stored with the humidity below 30%RH
 - c: If not finish the soldering in 12hours, need to bake the LED again at 65°C~70°C for 24hours