

PRODUCT SPECIFICATION

Model No.: FYLP-3W-UWS30-A

Features:
<ul style="list-style-type: none"> ■ SMD Type ■ Size (mm):20.00*20.78*8.30 ■ Emitting Color: White. ■ Lens Type: Water clear. ■ SMT package ■ RoHS Compliant ■ MSL:6

Applications:
<ul style="list-style-type: none"> ■ Light Strips ■ LCD Backlight ■ Decorative lighting ■ Indicators ■ Interior automotive ■ Illuminations ■ Mobile Phones



CUSTOMER APPROVED SIGNATURES	APPROVED BY	CHECKED BY	PREPARED BY

NINGBO FORYARD OPTOELECTRONICS CO.,LTD.

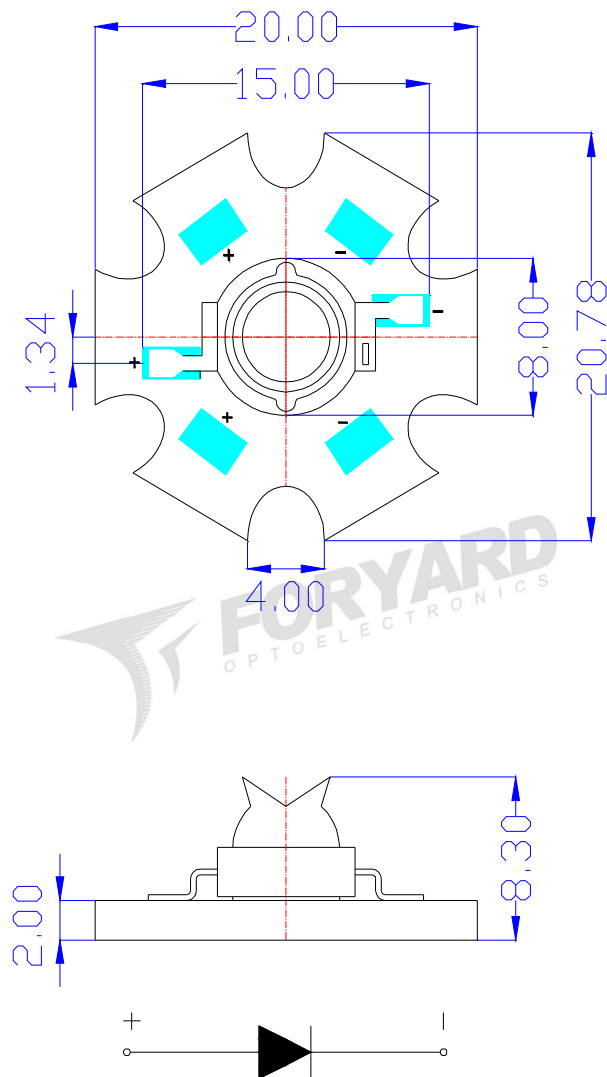
Add:No. 666 Jinghua Road, Hi-tech Park, Ningbo, Zhejiang, China

Zip:315103

Tel: 0086-574-87933652 87927870 87922206

Fax: 0086-574-87927917

E-mail:Sales@foryard.com (General)

Model No.: FYLP-3W-UWS30-A
■ Mechanical Dimensions

Notes:

1. Dimension in millimeter, tolerance is ± 0.10 .
2. Angle: $\pm 5^\circ$
3. The specifications, characteristics and technical data described in the datasheet are subject to change without prior notice.
4. The drawing is different from the actual one, please refer to the sample.

Model No.: FYLP-3W-UWS30-A

Absolute Maximum Ratings(Ta=25°C)

Parameter	Symbol	MAX.	Unit
Power Dissipation	PD	3000	mW
Peak Forward Current*	IFP	700	mA
Continuous Forward Current	IF	700	mA
Reverse Voltage	VR	5	V
Operating Temperature Range	Topr	-20~ +75	°C
Storage Temperature Range	Tstg	-40~ +100	°C

*1/10 Duty Cycle, 0.1ms Pulse Width

Typical Electrical &Optical Charcteristics(Ta=25°C)

Parameter	Symbol	Test Condition	Min.	Typ.	Max.	Unit
Forward Voltage	V _F	IF=700mA	2.8	3	3.6	V
Reverse Current	I _R	VR=5V	---	---	10	μA
Chromaticity coordinates	X	IF=700mA	---	0.465	---	---
	Y	IF=700mA	---	0.465	---	---
Color temperature	CCT	IF=700mA	2800	---	3200	K
Luminous Flux	Φ	IF=700mA	220	---	260	Lm
Color Rendering Index	Ra	IF=700mA	---	80	---	---
Viewing Angle	2θ _{1/2}	IF=700mA	---	120	---	Deg

Material

Item	Reflector	Wire	Encapsulate	Chip
Material	PPA	Gold	Silicone	InGaN/GaN

Note:

- 1.Luminous Intensity is based on the Foryard standards.
- 2.Pay attention about static for InGaN

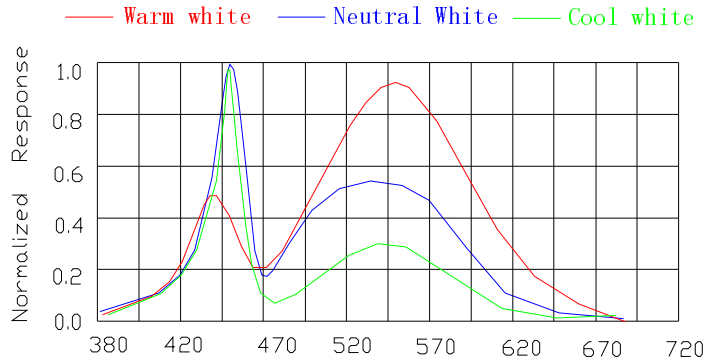
Model No.: FYLP-3W-UWS30-A
Electrical-Optical Characteristics-


Fig.1-Relative luminous Intensity vs. Forward Current

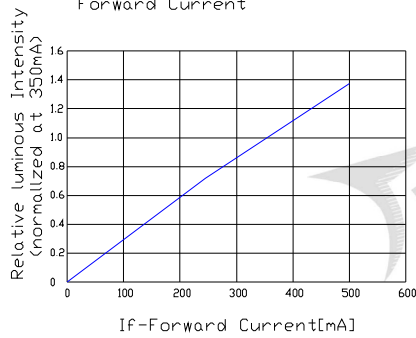


Fig.2-Forward Current vs. Forward Voltage

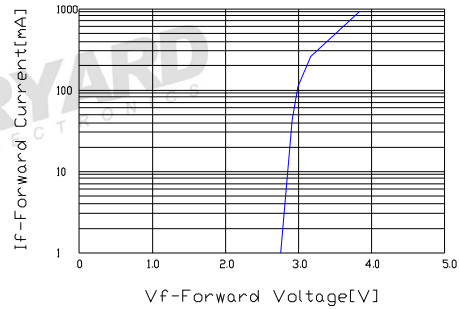


Fig.3-Relative Intensity(@350mA) vs. Ambient Temperature

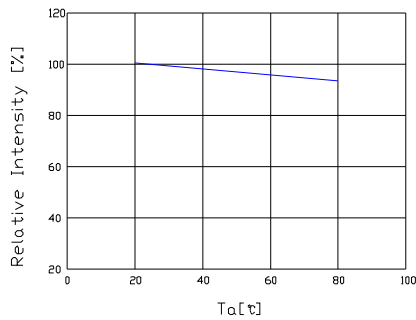


Fig.4-Forward Voltage(@350mA) vs. Ambient Temperature

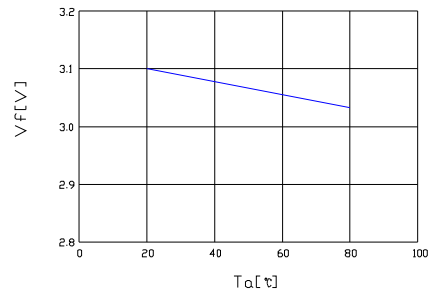


Fig.5-Maximum Driving Forward DC Current vs. Ambient Temperature (De-rating based on Tj max.=125°C)

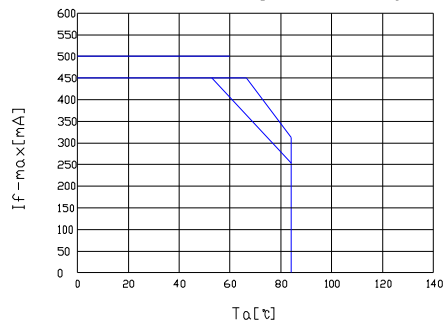
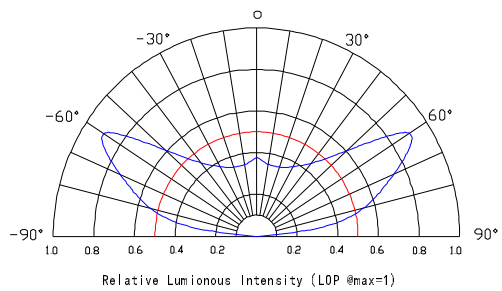


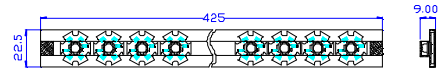
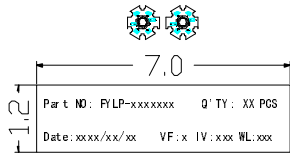
Fig.6-Radiation pattern



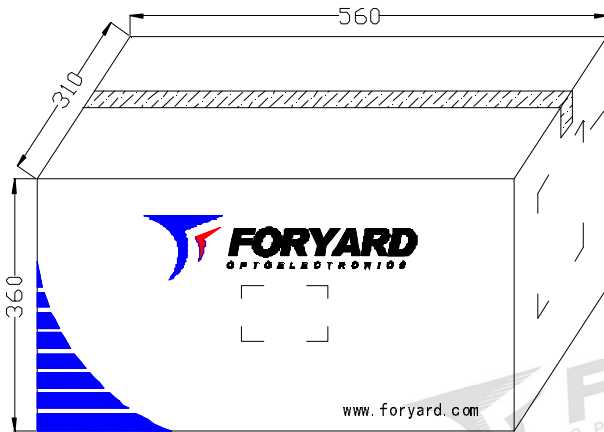
NOTE:25°C free air temperature unless otherwise specified

Model No.: FYLP-3W-UWS30-A

Package-

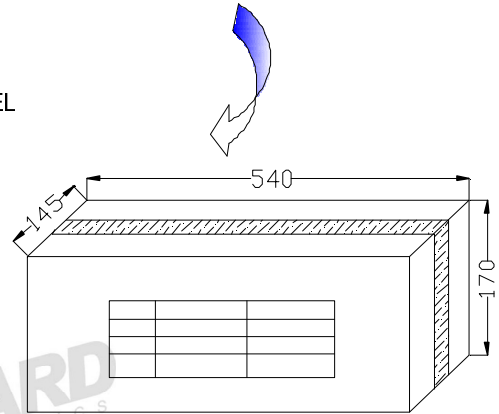


20PCS/Tube




6Box/Carton

OUTSIDE LABEL



108 Tube/Box



LED

PN: FYLP-XX-XXX-X

Qty: XXXXX PCS


Date: xxxx/xx/xx

GW: XX KG QC: PASS

NW: XX KG QC



XXXXXXXXXX




OUTSIDE LABEL

Notice:

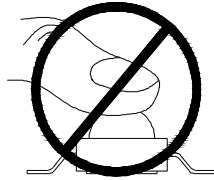
- 1.Quantity:20 PCS/Tube
- 2.Tolerance unless mentioned is $\pm 0.2\text{mm}$
- 3.The specifications are subject to change without notice. Please contact us for updated information.

Model No.: FYLP-3W-UWS30-A

■ **Handling of Silicone Resin LEDs-**

● **Handling Indications**

When handling the product, do not touch it directly with bare hands as it may contaminate the surface and affect on optical characteristics. In the worst cases, excessive force to the product might result in catastrophic failure due to package damage and/or wire breakage.

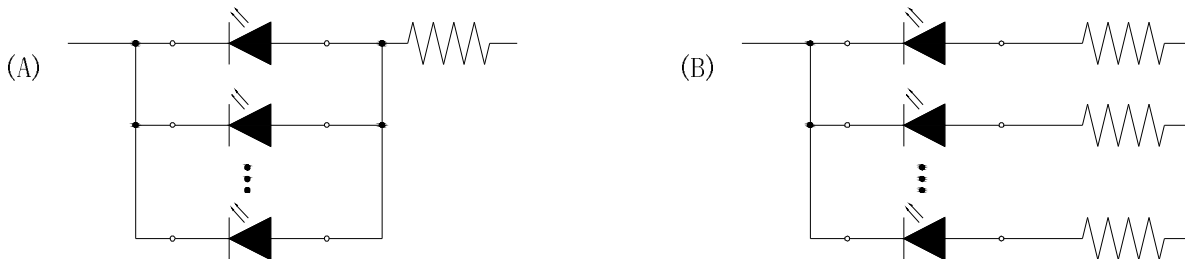


When handling the product with tweezers, LEDs should only be handled from the side and make sure that excessive force is not applied to the resin portion of the product. Failure to comply can cause the resin portion of the product to be cut, chipped, delaminated and/or deformed, and wire to be broken, and thus resulting in catastrophic failure.



■ **Recommended circuit-**

● In designing a circuit, the current through each LED must not exceed the absolute maximum rating specified for each LED. It is recommended to use Circuit B which regulates the current flowing through each LED. In the meanwhile, when driving LEDs with a constant voltage in Circuit A, the current through the LEDs may vary due to the variation in forward voltage (VF) of the LEDs. In the worst case, some LED may be subjected to stresses in excess of the absolute maximum rating.



● This product should be operated in forward bias. A driving circuit must be designed so that the product is not subjected to either forward or reverse voltage while it is off. In particular, if a reverse voltage is continuously applied to the product; such operation can cause migration resulting in LED damage.

■ **Storage-**

● **Storage Conditions**

1. Unopened moisture barrier bag (MBB) shall be stored at temperature below 5°C~30°C, with humidity below 60%RH.
2. Before the MBB be opened, check if have the air leakage, if have, then need to bake at 65°C~70°C for 24hours.
3. After the MBB has been opened, the LEDs which need for reflow soldering or other soldering methods, must be used according to below:
 - a: Must finish the soldering in 12hours
 - b: Stored with the humidity below 30%RH
 - c: If not finish the soldering in 12hours, need to bake the LED again at 65°C~70°C for 24hours