

PRODUCT SPECIFICATION

Model No.: FYL-3004YD1D

Descriptions:
<ul style="list-style-type: none"> ■ Dice material: GaAsP. ■ Emitting Color: Yellow. ■ Device Outline: Φ3mm round type. ■ Lens Type: Yellow Diffused.



CUSTOMER APPROVED SIGNATURES	APPROVED BY	CHECKED BY	PREPARED BY

NINGBO FORYARD OPTOELECTRONICS CO.,LTD.

Add:No. 666 Jinghua Road, Hi-tech Park, Ningbo, Zhejiang, China

Zip:315103

Tel: 0086-574-87933652 87922206 87927870

Fax: 0086-574-87927917

E-mail:Sales@foryard.com (General)

Model No.: FYL-3004YD1D

■ Absolute Maximun Ratings(Ta=25°C)

Parameter	MAX.	Unit
Power Dissipation	80	mW
Peak Forward Current (1/10 Duty Cycle, 0.1ms Pulse Width)	150	mA
Continuous Forward Current	30	mA
Derating Linear From 50°C	0.4	mA/°C
Reverse Voltage	5	V
Operating Temperature Range	-40°C to +85°C	
Storage Temperature Range	-40°C to +100°C	
Lead Soldering Temperature[4mm(.157") From Body]	260°C for 5 Seconds	

■ Typical Electrical & Optical Charcteristics(Ta=25°C)

Parameter	Symbol	Min.	Typ.	Max.	Unit	Test Condition
Luminous Intensity	I_v	30	55	80	mcd	IF=20mA
Viewing Angle	$2\theta_{1/2}$	---	40	---	Deg	
Peak Emission Wavelength	λ_p	---	590	--	nm	
Dominant Wavelength	λ_d	585	590	595	nm	
Spectral Line Half-Width	$\Delta\lambda$	---	35	--	nm	
Forward Voltage	V_F	1.8	2.1	2.4	V	VR=5V
Reverse Current	I_R	---	---	10	μA	

Note:

- 1.Luminous Intensity is based on the Foryard standards.
- 2.Pay attention about static for InGaN

Model No.: FYL-3004YD1D

Typical Electrical/Optical Characteristics Curves(Ta=25°C Unless Otherwise Noted)

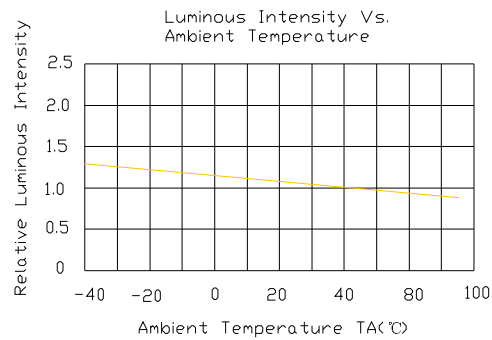
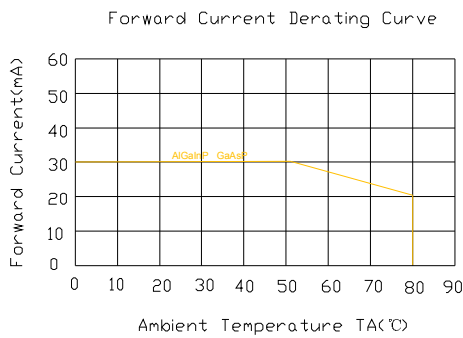
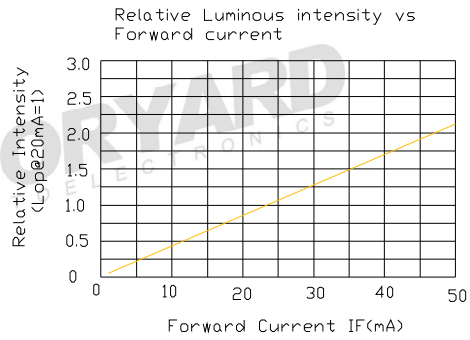
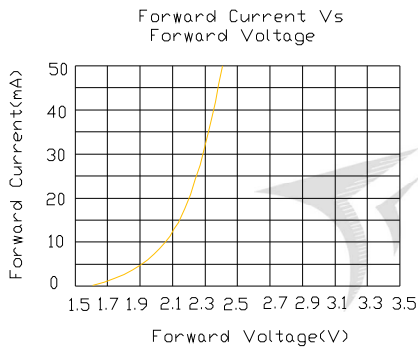
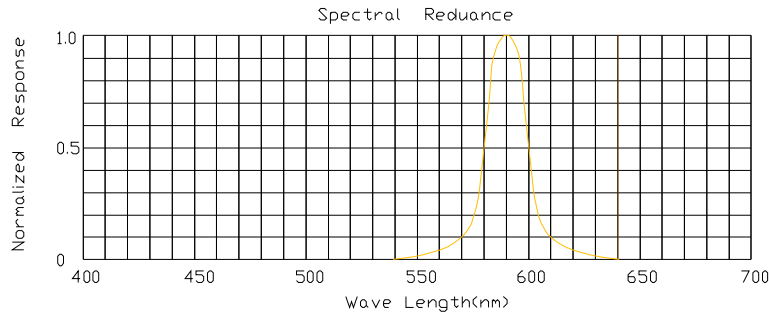

Radiation pattern

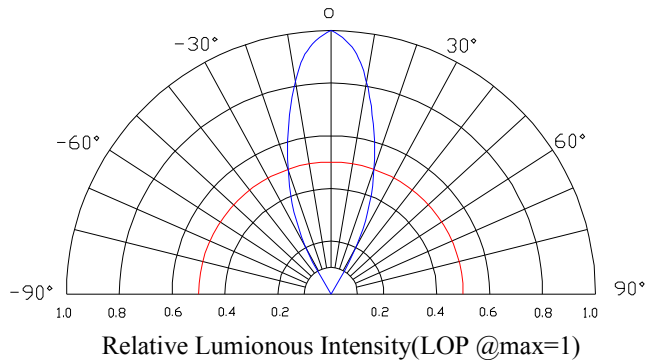

Model No.	FYL-3004YD1D
Date / Rev.	2021.05.10 / B

Model No.: FYL-3004YD1D

■ LAMP PACKING.

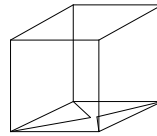
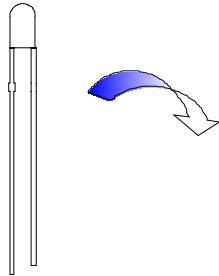

3mm 1000PCS/Polybag

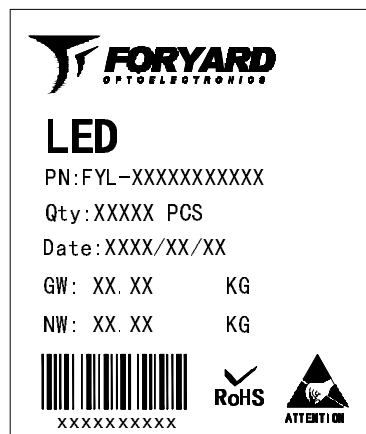
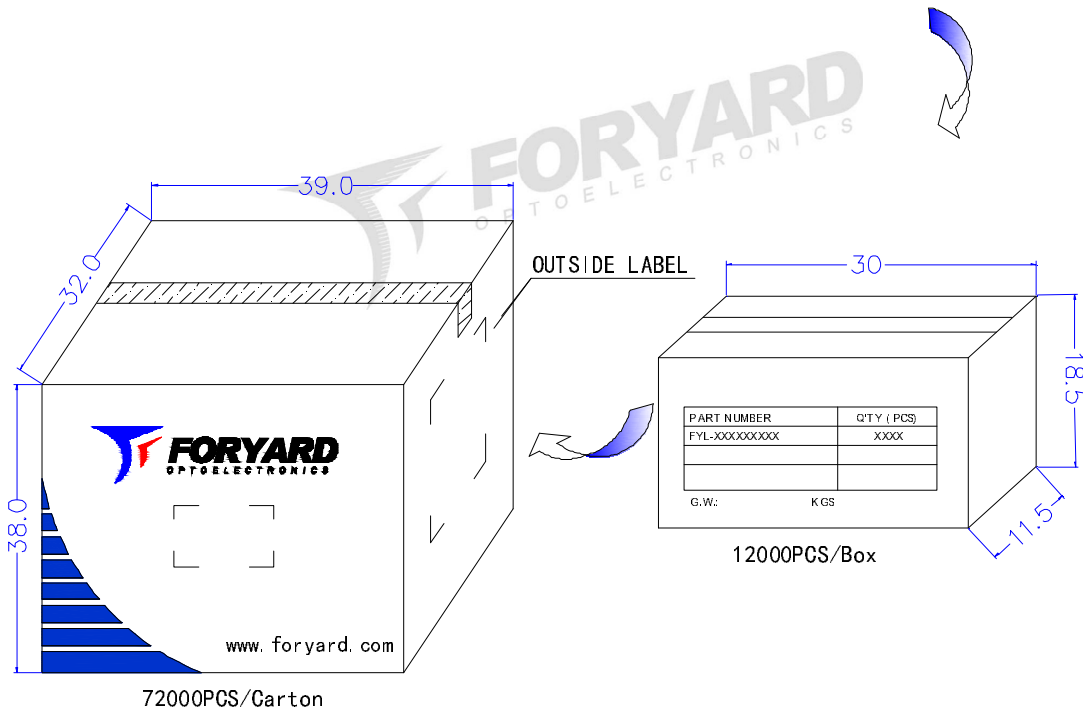

OUTSIDE LABEL

Note: The specifications are subject to change without notice. Please contact us for updated information.