

PRODUCT SPECIFICATION

Model No.: FYL-5019URUGW1B-CC

Descriptions:
<ul style="list-style-type: none"> ■ Dice material: AlGaInP;AlGaInP. ■ Emitting Color: Super Bright Red;Super Bright Yellow Green. ■ Device Outline: Φ5mm round type. ■ Lens Type: White Diffused.



CUSTOMER APPROVED SIGNATURES	APPROVED BY	CHECKED BY	PREPARED BY

NINGBO FORYARD OPTOELECTRONICS CO.,LTD.

Add:No. 666 Jinghua Road, Hi-tech Park, Ningbo, Zhejiang, China

Zip:315103

Tel: 0086-574-87933652 87922206 87927870

Fax: 0086-574-87927917

E-mail:Sales@foryard.com (General)

Model No.: FYL-5019URUGW1B-CC

■ Features

- 1.Low power consumption.
- 2.High efficiency.
- 3.General purpose leads.
- 4.High intensity.
- 5.RoHs compliant.

■ Package configuration

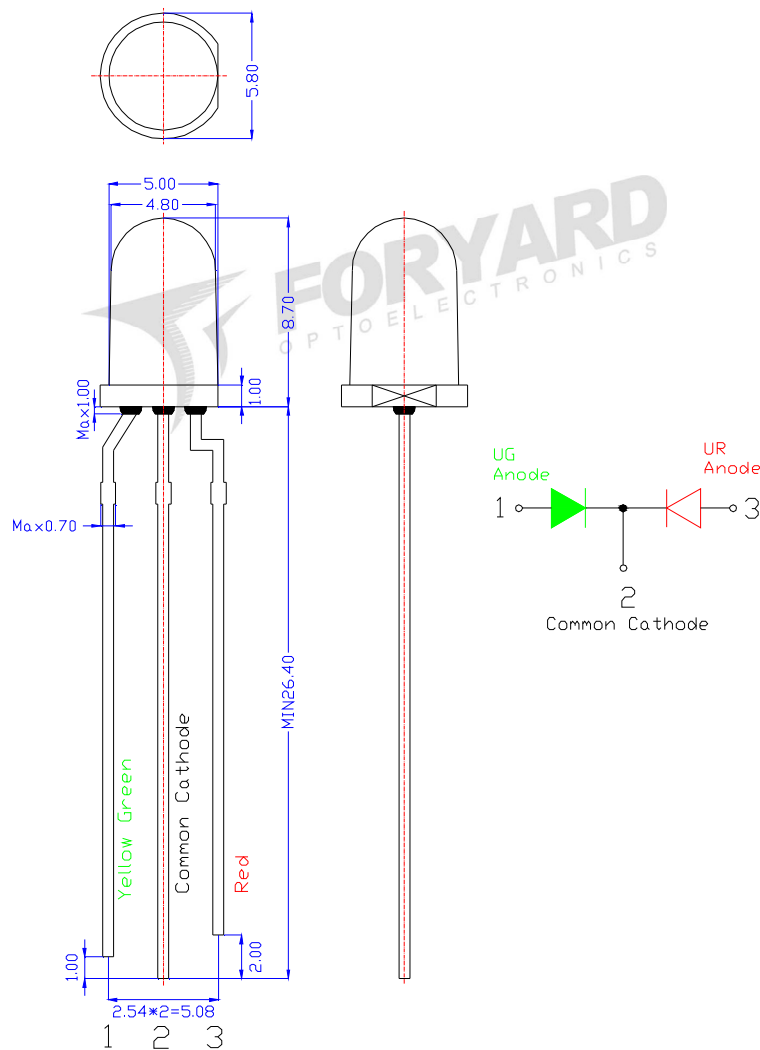

Notes:

1. All dimensions are millimeters (inches)
2. Tolerance is $\pm 0.25\text{mm}$ (.010") unless otherwise noted.
3. The specifications, characteristics and technical data described in the datasheet are subject to change without prior notice.
4. The drawing is different from the actual one, please refer to the sample.

Model No.: FYL-5019URUGW1B-CC

■ Absolute Maximum Ratings(Ta=25°C)

Parameter	MAX.		Unit
	UR	UG	
Power Dissipation	75	75	mW
Peak Forward Current (1/10 Duty Cycle, 0.1ms Pulse Width)	100	100	mA
Continuous Forward Current	30	30	mA
Derating Linear From 50°C	0.4		mA/°C
Reverse Voltage	5		V
Operating Temperature Range	-40°C to +85°C		
Storage Temperature Range	-40°C to +100°C		
Lead Soldering Temperature[4mm(.157") From Body]	260°C for 5 Seconds		

■ Typical Electrical & Optical Characteristics(Ta=25°C)

Parameter	Symbol	Colour	Min.	Typ.	Max.	Unit	Test Condition
Luminous Intensity	I_v	UR	700	1500	2300	mcd	IF=20mA
		UG	150	360	700		
Viewing Angle	$2\theta_{1/2}$	UR	---	25	---	Deg	
		UG	---	25	--		
Peak Emission Wavelength	λ_p	UR	---	630	--	nm	
		UG	---	570	--		
Dominant Wavelength	λ_d	UR	618	625	630	nm	
		UG	568	572	574		
Spectral Line Half-Width	$\Delta\lambda$	UR	---	20	--	nm	
		UG	---	30	--		
Forward Voltage	V_F	UR	1.8	2.1	2.4	V	
		UG	1.8	2.1	2.6		
Reverse Current	I_R		---	---	10	μA	VR=5V

Note:

- 1.Luminous Intensity is based on the Foryard standards.
- 2.Pay attention about static for InGaN

Model No.: FYL-5019URUGW1B-CC

Typical Electrical/Optical Characteristics Curves(Ta=25°C Unless Otherwise Noted)

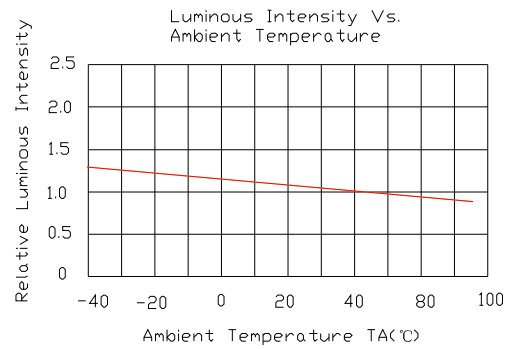
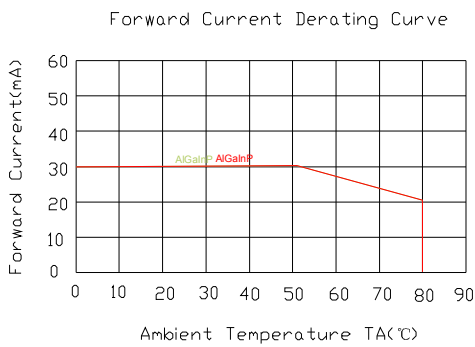
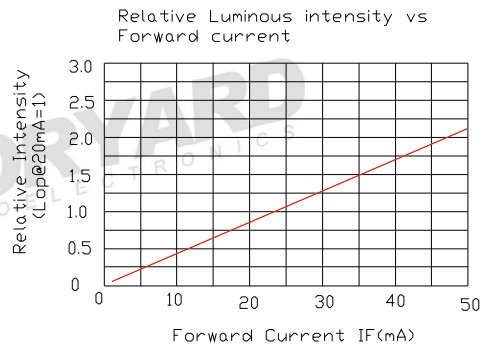
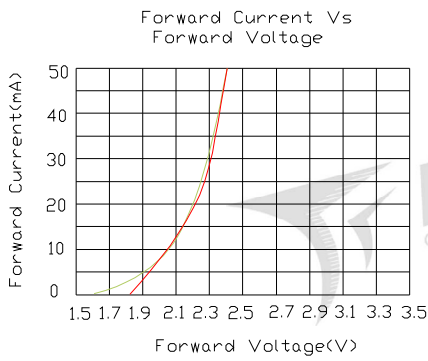
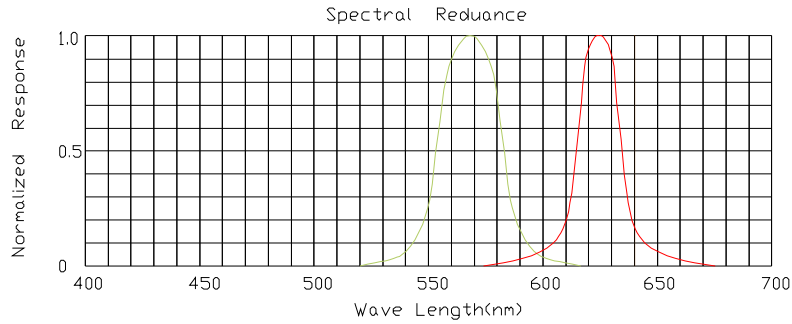

Radiation pattern

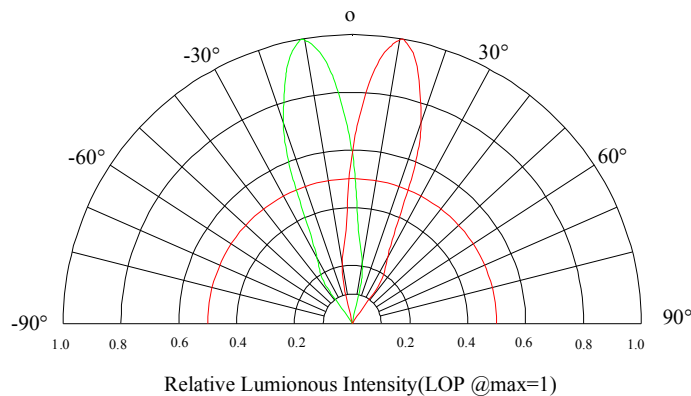

Model No.: FYL-5019URUGW1B-CC

■ LAMP PACKING.

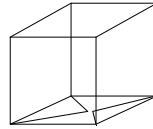
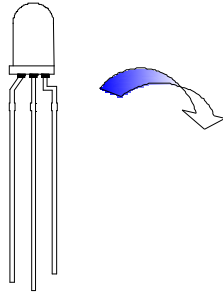

5mm 500PCS/Polybag

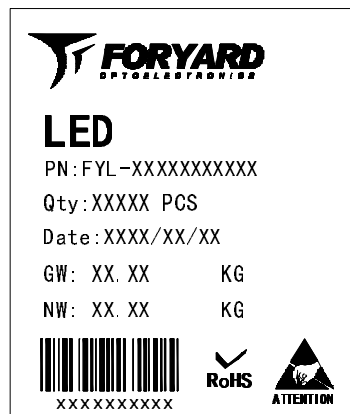
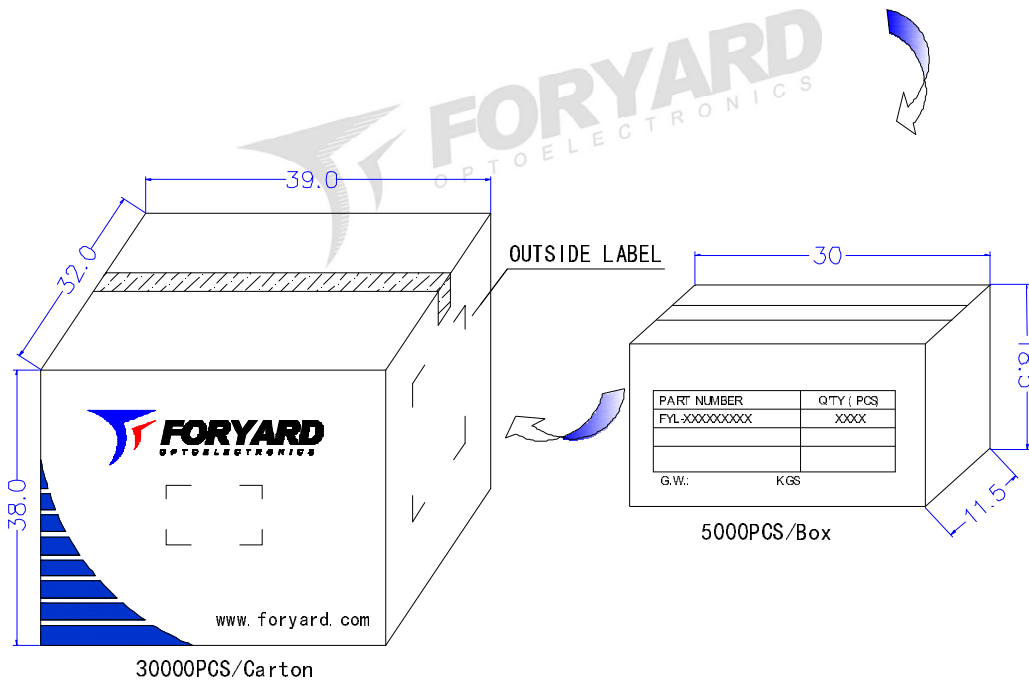

OUTSIDE LABEL

Note: The specifications are subject to change without notice. Please contact us for updated information.