

PRODUCT SPECIFICATION

Model No.: FYSH-3535RGBC-60-12V-NW6

Features:

- Wide viewing separable flexible strip to be bent into any shape
- Double side self-adhesive 3M tape for easy installation
- High brightness, long life-span
- Product is Non-waterproof

Applications:

- Channel Letters
- Lighting source for shop windows
- Indoor Decoration Lighting
- Advertising Signs
- Replacement for Neon



CUSTOMER APPROVED SIGNATURES	APPROVED BY	CHECKED BY	PREPARED BY

NINGBO FORYARD OPTOELECTRONICS CO.,LTD.

Add:No. 666 Jinghua Road, Hi-tech Park, Ningbo, Zhejiang, China

Zip:315103

Tel: 0086-574-87933652 87922206 87927870

Fax: 0086-574-87927917

E-mail:Sales@foryard.com (General)

Model No.	FYSH-3535RGBC-60-12V-NW6
Date / Rev.	2020.08.04 / A

Model No.: FYSH-3535RGBC-60-12V-NW6

Technical Features:

1. Very low energy consumption
2. No UV radiation in the light beam
3. Top Viewing
4. Unique circuit design with strong resistance against static electricity

Drawing:

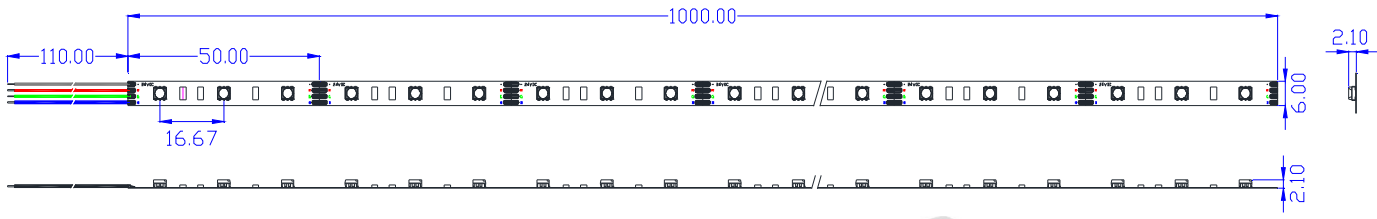

Schematic Diagram:

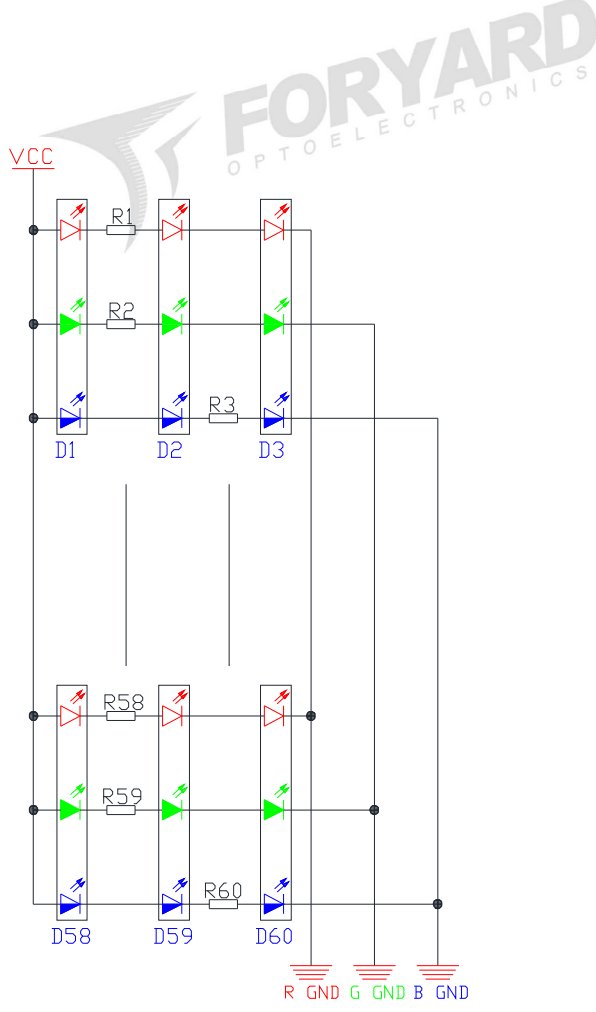

Notes:

1. All dimensions are millimeters.
2. Tolerance is ± 1 mm unless otherwise specified.
3. Specifications are subject to change without notice.
4. The drawing is different from the actual one, please refer to the sample.

Model No.	FYSH-3535RGBC-60-12V-NW6
Date / Rev.	2020.08.04 / A

Model No.: **FYSH-3535RGBC-60-12V-NW6**



■ Rating Electrical/Optical Characteristics(1 meter)

Item	Red	Green	Blue
Operation Voltage(V)	DC 12		
Input Current(A)	0.4		
Wavelength(nm)	623±5	520±5	465±5
Color Temp(K)	/	/	/
Luminous Flux(lm)	120	240	60
Power Dissipation(W)	4.8	4.8	4.8
High light efficiency (lm/W)	25	50	12.5
LED Quantity(pcs)	60		
CRI	/		
Total dimension	L1000 mm x W6mm x H2.1mm		
Protection Level	IP20		
Angle(°)	120		
Operation Temperature(°C)	-40~+60°C		

Model No.	FYSH-3535RGBC-60-12V-NW6
Date / Rev.	2020.08.04 / A

Model No.: FYSH-3535RGBC-60-12V-NW6

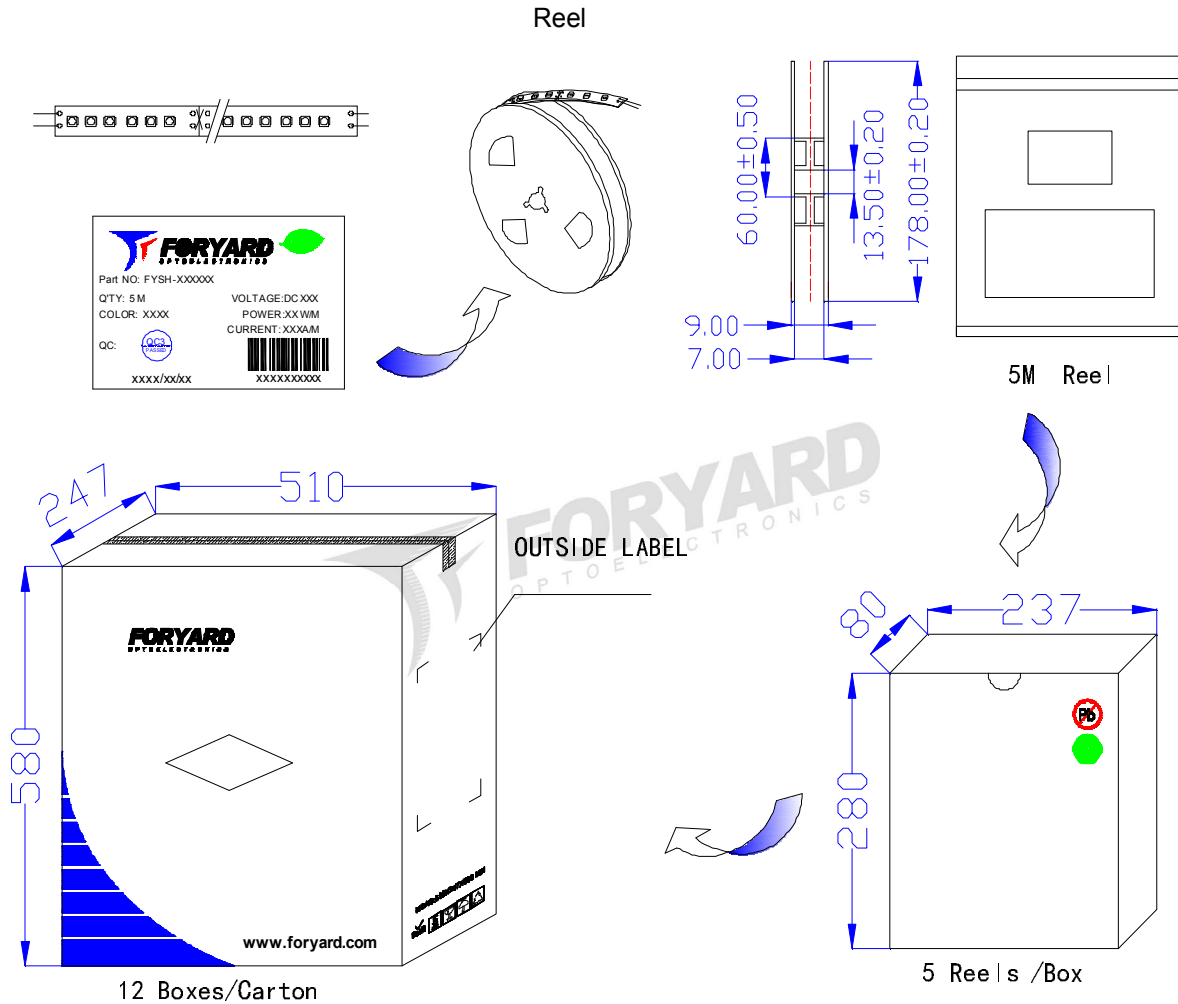
■ Package

LED

PN: FYSH-XXXXXXXXXX

Qty: XXXXX M



Date: XXXX/XX/XX

GW: XX.XX KG

NW: XX.XX KG



XXXXXXXXXX

OUTSIDE LABEL

Note: The specifications are subject to change without notice. Please contact us for updated information.

Model No.: **FYSH-3535RGBC-60-12V-NW6**

■ Typical Electrical/Optical Characteristics Curves(Ta=25°C Unless Otherwise Noted)

Assembly Suggestion :

1. Connection with soldering wires on unmouted strip: Do not pretin the soldering pads but pretin the wires wires and solder for max 4s at 300°C. Allow soldering pads to completely cool down before the next soldering.
2. There is 3M double side adhesive tape on the backside for easy installation. Care must be taken to provide a clean and dry surface. The mounting substrate must have sufficient structural integrity. Take care to completely remove the protective backing. Once the strip is appropriately positioned, press on the strip to fasten it.
3. The minimum bending radius is 2cm. The strip may be bent over a smaller radius but only in regions of the circuit board containing no electronic components and such bends should be made once and fixed in position to avoid cyclic fatigue.

Precaution:

1. The LED strip does not have protection against short circuit, overload or overheating. Therefore it is absolutely necessary to operate the strips with an electronically stable power supply offering protection against the above mentioned safety risks.
2. Installation of LED strips (with power supplies) should be made with regard to all applicable electrical and safety standards. Only qualified personnel should be allowed to perform installations.
3. Pay attention to standard ESD precautions when installing the strips.
4. Assembly must not damage or destroy conducting paths on the circuit board.
5. The max length per loop should not exceed 7 meters, otherwise, due to voltage drop, there will be color and brightness difference between the LED's near to power supply and the ones are far away from power supply.
6. The wire with gray line is anode, whiles the red, green, blue, yellow, white is cathode. Wrong polarity will lead to no light emission only; the strip will not be destroyed. What only needs to is to correct polarity;
7. When installing the strips in the plastic letters or characters, please try to use 3 or 4 branch wires and when doing the connection try to make the strips in a letter or character from a loop circuit or several loop circuits by using red and black wire to connect the strips at the end of the strokes together according to their polarities.
8. When mounting on metallic or otherwise conductive surfaces, there needs to be an electrical isolation at soldering points between strip and the mounting surface.
9. No push, squeeze or press on the components of the strip for fear damaging the electrical components