

PRODUCT SPECIFICATION

Model No.: FYL-48D4UWC1A

Descriptions:
<ul style="list-style-type: none"> ■ Dice material: InGaN. ■ Emitting Color: Super Bright Cool White. ■ Device Outline: Φ4.8mm helmet type. ■ Lens Type: Water clear.

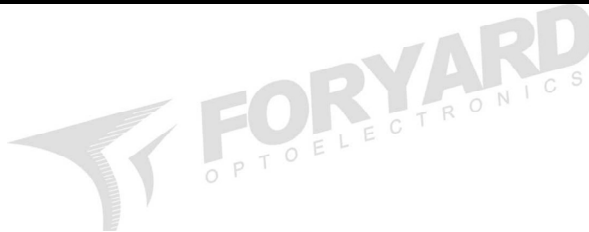

CUSTOMER APPROVED SIGNATURES	APPROVED BY	CHECKED BY	PREPARED BY

NINGBO FORYARD OPTOELECTRONICS CO.,LTD.

Add:No. 666 Jinghua Road, Hi-tech Park, Ningbo, Zhejiang, China

Zip:315103

Tel: 0086-574-87933652 87922206 87927870

Fax: 0086-574-87927917

E-mail:Sales@foryard.com (General)

Model No.: FYL-48D4UWC1A

■ Features

- 1.Low power consumption.
- 2.High efficiency.
- 3.General purpose leads.
- 4.High intensity.
- 5.RoHs compliant.

■ Package configuration

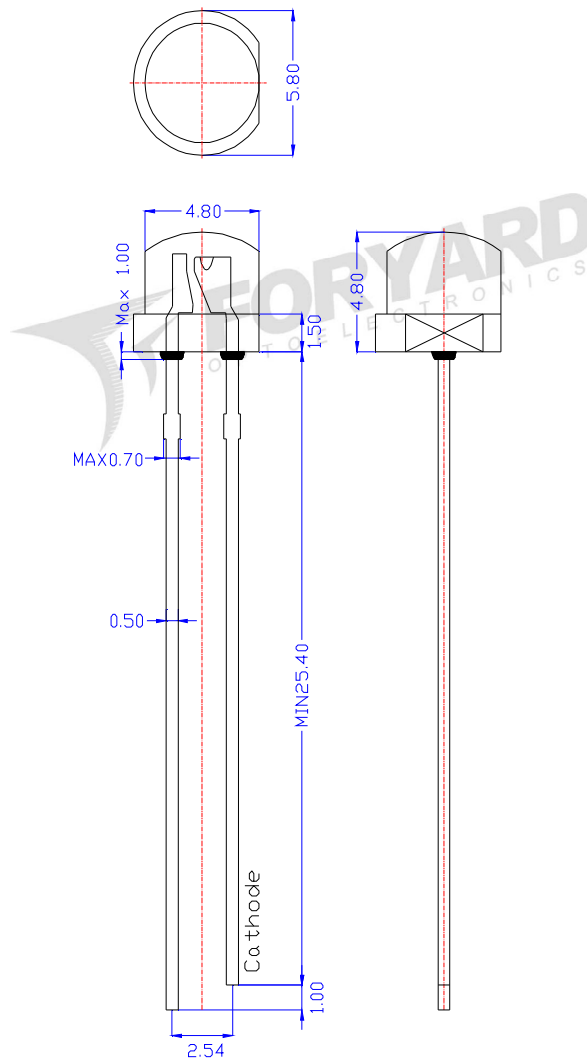

Notes:

1. All dimensions are millimeters (inches)
2. Tolerance is $\pm 0.25\text{mm}$ (.010") unless otherwise noted.
3. The specifications, characteristics and technical data described in the datasheet are subject to change without prior notice.
4. The drawing is different from the actual one, please refer to the sample.

Model No.: FYL-48D4UWC1A

■ Absolute Maximun Ratings(Ta=25°C)

Parameter	MAX.	Unit
Power Dissipation	100	mW
Peak Forward Current (1/10 Duty Cycle, 0.1ms Pulse Width)	100	mA
Continuous Forward Current	30	mA
Derating Linear From 50°C	0.4	mA/°C
Reverse Voltage	5	V
Operating Temperature Range	-40°C to +85°C	
Storage Temperature Range	-40°C to +100°C	
Lead Soldering Temperature[4mm(.157") From Body]	260°C for 5 Seconds	

■ Typical Electrical & Optical Charcteristics(Ta=25°C)

Parameter	Symbol	Min.	Typ.	Max.	Unit	Test Condition
Luminous Intensity	I_V	1200	1800	3000	mcd	IF=20mA
Viewing Angle	$2\theta_{1/2}$	---	130	---	Deg	
Color temperature	CCT	6000	9500	---	K	
Chromaticity coordinates	X	0.32	0.285	---	---	
	Y	0.32	0.285	---		
Forward Voltage	V_F	2.6	3	3.4	V	
Reverse Current	I_R	---	---	10	μA	VR=5V

Note:

- 1.Luminous Intensity is based on the Foryard standards.
- 2.Pay attention about static for InGaN

■ Luminous Intensity Guide (Unit: mcd) @IF=20mA

Code	W8	W9	W10	W11
Luminous Intensity(mcd)	1200~1500	1500~1800	1800~2200	2200~3000

Tolerance of measurement of luminous intensity is $\pm 15\%$

■ Forward Voltage Guide (Unit: V) @IF=20mA

Code	V6	V7	V8	V9
Forward Voltage(V)	2.6~2.8	2.8~3.0	3.0~3.2	3.2~3.4

Tolerance of measurement of forward voltage is $\pm 0.1V$

Model No.: FYL-48D4UWC1A

Chromaticity Coordinate Grade of White Chip-LED Products

Test Condition: If=20mA, Ta=25°C

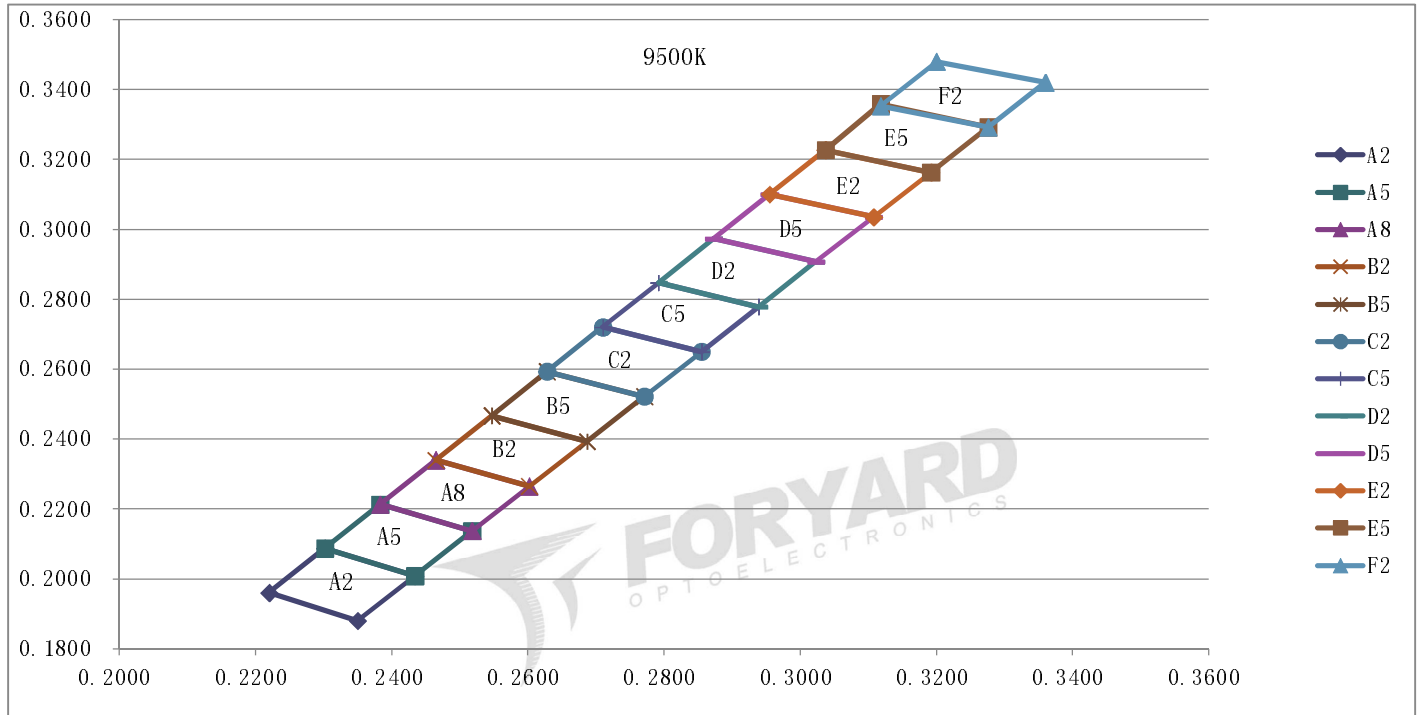

F2	X	0.3200	0.3360	0.3276	0.3118	E5	X	0.3118	0.3276	0.3192	0.3037
	Y	0.3480	0.3420	0.3292	0.3353		Y	0.3358	0.3292	0.3163	0.3227
E2	X	0.3037	0.3192	0.3108	0.2955	D5	X	0.2955	0.3108	0.3023	0.2873
	Y	0.3227	0.3163	0.3035	0.3100		Y	0.3100	0.3035	0.2907	0.2973
D2	X	0.2873	0.3023	0.2939	0.2792	C5	X	0.2792	0.2939	0.2855	0.2710
	Y	0.2973	0.2907	0.2778	0.2847		Y	0.2847	0.2778	0.2650	0.2720
C2	X	0.2710	0.2855	0.2771	0.2628	B5	X	0.2628	0.2771	0.2687	0.2547
	Y	0.2720	0.2650	0.2522	0.2593		Y	0.2593	0.2522	0.2393	0.2467
B2	X	0.2547	0.2687	0.2602	0.2465	A8	X	0.2465	0.2602	0.2518	0.2383
	Y	0.2467	0.2393	0.2265	0.2340		Y	0.2340	0.2265	0.2137	0.2213
A5	X	0.2383	0.2518	0.2434	0.2302	A2	X	0.2302	0.2434	0.2350	0.2220
	Y	0.2213	0.2137	0.2008	0.2087		Y	0.2087	0.2008	0.1880	0.1960

Model No.: FYL-48D4UWC1A

Typical Electrical/Optical Characteristics Curves(Ta=25°C Unless Otherwise Noted)

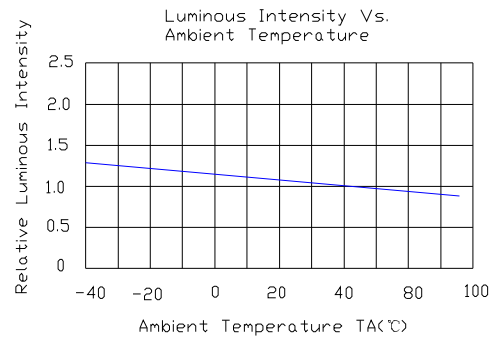
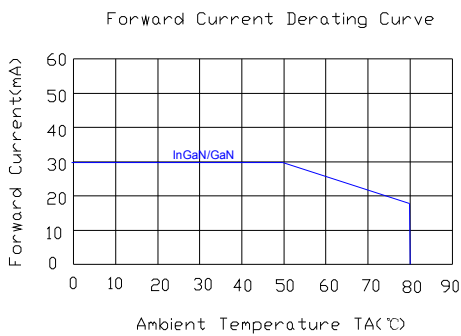
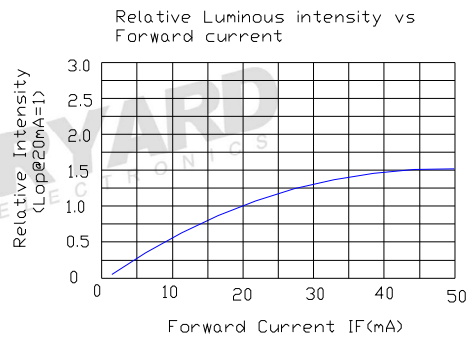
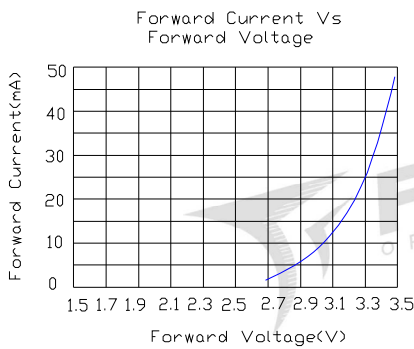
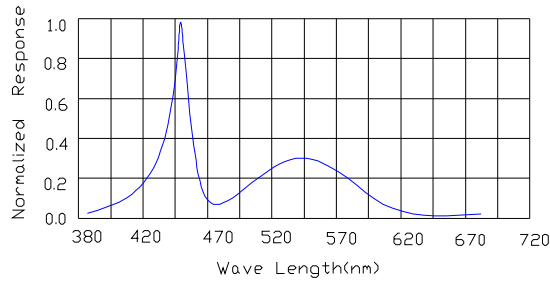

Radiation pattern

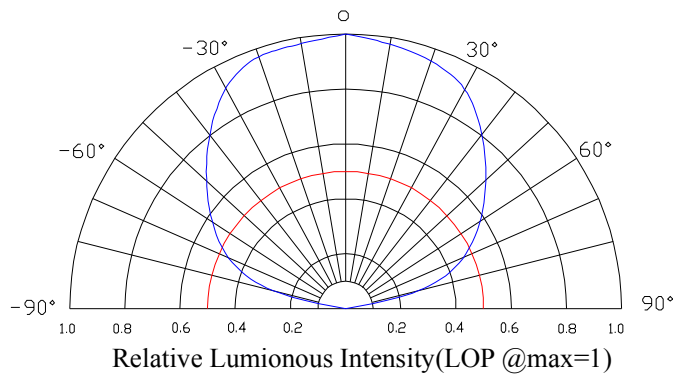

Model No.: FYL-48D4UWC1A

■ LAMP PACKING.

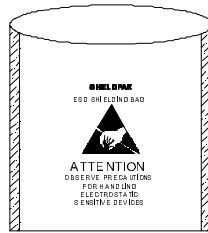
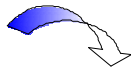
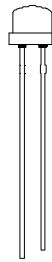

4.8mm 500PCS/Polybag

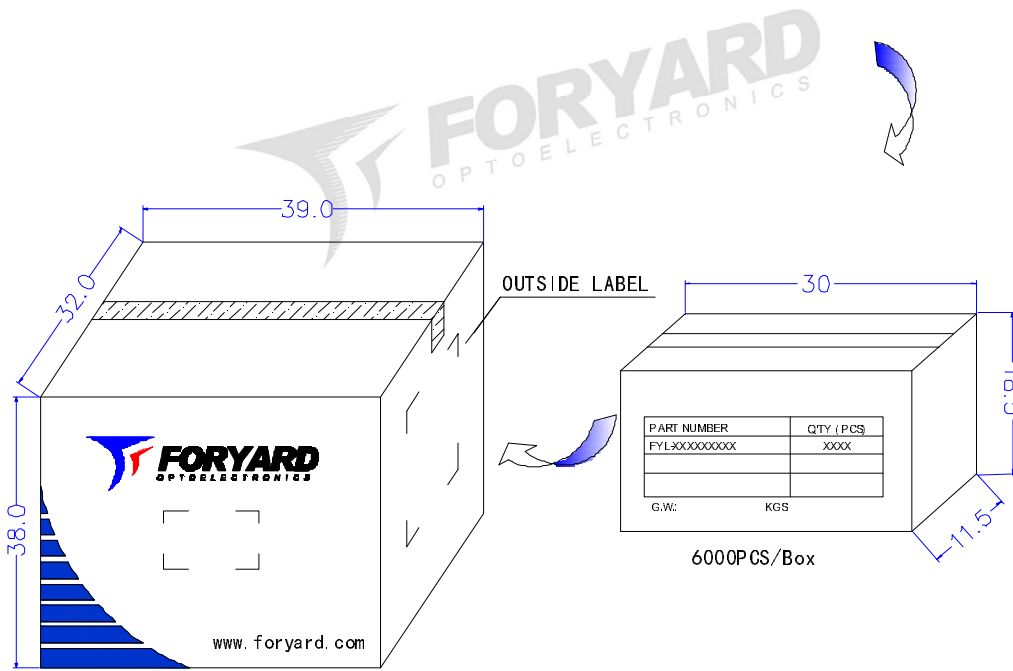

36000PCS/Carton

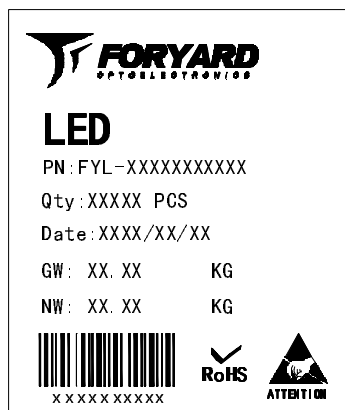

OUTSIDE LABEL

Note: The specifications are subject to change without notice. Please contact us for updated information.