

# PRODUCT SPECIFICATION

**Model No.: FYLS-0603FXXXC**

Features:
<ul style="list-style-type: none"> <li>■ SMD Type</li> <li>■ Size (mm):1.60*0.80*0.95</li> <li>■ Lens Color: Water clear.</li> <li>■ Viewing Angle(2θ<sup>1/2</sup>):30°</li> <li>■ SMT package</li> <li>■ Suitable for all SMT assembly and soldering method</li> <li>■ Pb-free Reflow soldering application</li> <li>■ RoHS Compliant</li> <li>■ MSL:4</li> </ul>

Applications:
<ul style="list-style-type: none"> <li>■ Light Strips</li> <li>■ LCD Backlight</li> <li>■ Decorative lighting</li> <li>■ Indicators</li> <li>■ Interior automotive</li> <li>■ Illuminations</li> <li>■ Mobile Phones</li> </ul>



CUSTOMER APPROVED SIGNATURES	APPROVED BY	CHECKED BY	PREPARED BY

**NINGBO FORYARD OPTOELECTRONICS CO.,LTD.**

**Add:**No. 666 Jinghua Road, Hi-tech Park, Ningbo, Zhejiang, China

**Zip:**315103

**Tel:** 0086-574-87933652 87927870 87922206

**Fax:** 0086-574-87927917

**E-mail:**Sales@foryard.com ( General)

**Model No.: FYLS-0603FXXXC**

**■ Mechanical Dimensions**

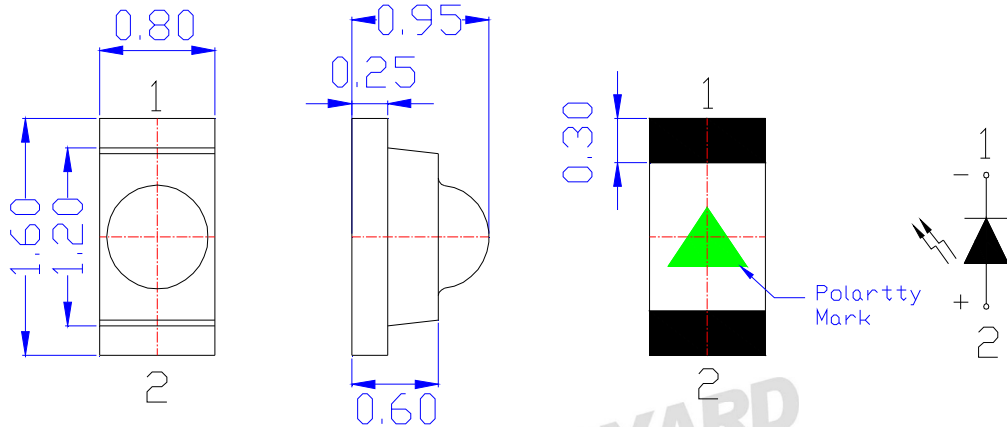

**■ Recommend Soldering pad design(unit=mm)**

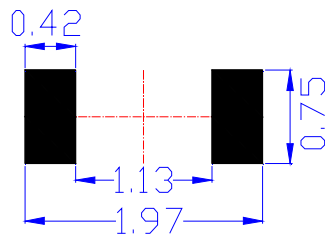

**Notes:**

1. Dimension in millimeter, tolerance is  $\pm 0.10$ .
2. Angle:  $\pm 5^\circ$
3. The specifications, characteristics and technical data described in the datasheet are subject to change without prior notice.
4. The drawing is different from the actual one, please refer to the sample.

**Model No.: FYLS-0603FXXXC**

**■ Absolute maximum ratings**

Parameter	Symbol	MAX.		Unit
		AlGaInP	InGaN/GaN	
Power Dissipation	PD	75	100	mW
Peak Forward Current*	IFP	80	80	mA
Continuous Forward Current	IF	30	30	mA
Reverse Voltage	VR	5		V
Reverse Current (VR=5V)	IR	10		u A
Operating Temperature Range	Topr	-30~ +85		℃
Storage Temperature Range	Tstg	-40~ +85		℃

\*1/10 Duty Cycle, 1ms Pulse Width

**■ Electrical-Optical Characteristics**

● Color Code & Chip Characteristics:(Test Condition : If=20mA,Ta=25℃)

Model No.:	Emitting Color	Dice Material	Peak Wave	Dominant Wave			Spectral Line	Forward Voltage(VF)			Luminous Intensity (lv) Unit:mcd		
			Length(AP) nm	Length(Ad) nm			halfwidth (Δλ1/2) nm	Unit:V			Unit:mcd		
Ultra brightness													
FYLS-0603FKURC	Ultra Red	AlGaInP	630	615	625	630	20	1.80	2.00	2.20	950	2000	2650
FYLS-0603FKUYC	Ultra Yellow	AlGaInP	593	586	590	594	20	1.90	2.10	2.30	180	500	850
FYLS-0603FPGC	Purea Green	InGaN/GaN	520	516	520	528	36	2.90	3.10	3.30	1150	2000	2650
FYLS-0603FUBC	Ultra Blue	InGaN/GaN	468	463.5	470	476	30	2.60	3.00	3.50	180	550	850

**■ Material**

Item	Reflector	Wire	Encapsulate
Material	/	Gold	Epoxy

Note:

- 1.Luminous Intensity is based on the Foryard standards.
- 2.Pay attention about static for InGaN

**Model No.: FYLS-0603FXXXC**

■ The Luminous Intensity Grade of Products(Unit: mcd) ;Test Condition: If=20mA,Ta=25℃

A		B		C		D		E		F	
A1	A2	B1	B2	C1	C2	D1	D2	E1	E2	F1	F2
0.10	0.20	0.40	0.70	1.20	2.20	3.60	5.10	7.20	9.00	11.50	14.50
0.20	0.40	0.70	1.20	2.20	3.60	5.10	7.20	9.00	11.50	14.50	18.00

G		H		J		K		L		M	
G1	G2	H1	H2	J1	J2	K1	K2	L1	L2	M1	M2
18.00	22.50	28.50	36.00	45.00	57.00	72.00	90.00	115.00	145.00	180.00	225.00
22.50	28.50	36.00	45.00	57.00	72.00	90.00	115.00	145.00	180.00	225.00	285.00

N		P		Q		R		SA		SB	
N1	N2	P1	P2	Q1	Q2	R1	R2	S1	S2	S3	S4
285.00	360.00	450.00	550.00	650.00	750.00	850.00	950.00	1050.00	1150.00	1250.00	1350.00
360.00	450.00	550.00	650.00	750.00	850.00	950.00	1050.00	1150.00	1250.00	1350.00	1450.00

SC		TA		TB		TC		UA		UB	
S5	S6	T1	T2	T3	T4	T5	T6	U1	U2	U3	U4
1450.00	1550.00	1650.00	1750.00	1850.00	1950.00	2050.00	2250.00	2450.00	2650.00	2850.00	3050.00
1550.00	1650.00	1750.00	1850.00	1950.00	2050.00	2250.00	2450.00	2650.00	2850.00	3050.00	3350.00

UC		VA		VB		VC		WA		WB	
U5	U6	V1	V2	V3	V4	V5	V6	W1	W2	W3	W4
3350.00	3650.00	3950.00	4250.00	4650.00	5050.00	5550.00	6050.00	6650.00	7250.00	7950.00	8650.00
3650.00	3950.00	4250.00	4650.00	5050.00	5550.00	6050.00	6650.00	7250.00	7950.00	8650.00	9450.00

WC		XA		XB		XC	
W5	W6	X1	X2	X3	X4	X5	X6
9450.00	10250.00	11250.00	13250.00	16250.00	19250.00	23250.00	27250.00
10250.00	11250.00	13250.00	16250.00	19250.00	23250.00	27250.00	32250.00

Tolerance of measurement of luminous intensity is ±15%

■ Forward Voltage Grade of Products (Unit: V); Test Condition: If=20mA,Ta=25℃

1	2	3	4	5	6	7	8	9	10	11	12
1.40	1.50	1.60	1.70	1.80	1.90	2.00	2.10	2.20	2.30	2.40	2.50
1.50	1.60	1.70	1.80	1.90	2.00	2.10	2.20	2.30	2.40	2.50	2.60

13	14	15	16	17	18	19	20	21	22	23	24
2.60	2.70	2.80	2.90	3.00	3.10	3.20	3.30	3.40	3.50	3.60	3.70
2.70	2.80	2.90	3.00	3.10	3.20	3.30	3.40	3.50	3.60	3.70	3.80

Tolerance of measurement of forward voltage is ±0.1V

**Model No.: FYLS-0603FXXXC**

■ Dominate Wavelength Grade of Products (Unit: nm); Test Condition: If=20mA, Ta=25°C

Red/Ultra Red			
UR			
0	1	2	3
620.00	623.00	627.00	632.00
623.00	627.00	632.00	640.00

Red	
SR/HR	
1	2
632.00	640.00
640.00	660.00

Orange/Ultra Orange			
E/UE			
1	2	3	4
614.00	618.00	622.00	627.00
618.00	622.00	627.00	632.00

Amber/Ultra Amber			
A/UA			
1	2	3	4
598.00	602.00	606.00	610.00
602.00	606.00	610.00	614.00

Yellow /Ultra Yellow					
Y/UY					
1	2	3	4	5	6
584.00	586.00	588.00	590.00	592.00	594.00
586.00	588.00	590.00	592.00	594.00	596.00

Yellow Green/Ultra Yellow Green				
G/UG				
0	1	2	3	4
568.00	570.00	572.00	574.00	576.00
570.00	572.00	574.00	576.00	578.00

Pura Green									
PG									
1	2	3	4	5	6	7	8	9	A
511.50	514.00	516.50	519.00	521.50	524.00	526.50	529.00	531.50	534.00
514.00	516.50	519.00	521.50	524.00	526.50	529.00	531.50	534.00	536.50

Ultra Blue					
UB					
0	1	2	3	4	5
460.00	463.50	466.00	468.50	471.00	473.50
463.50	466.00	468.50	471.00	473.50	476.00

Tolerance for each Dominate Wavelength bin is ±1nm



**Model No.: FYLS-0603FXXXC**

**Electrical-Optical Characteristics-**

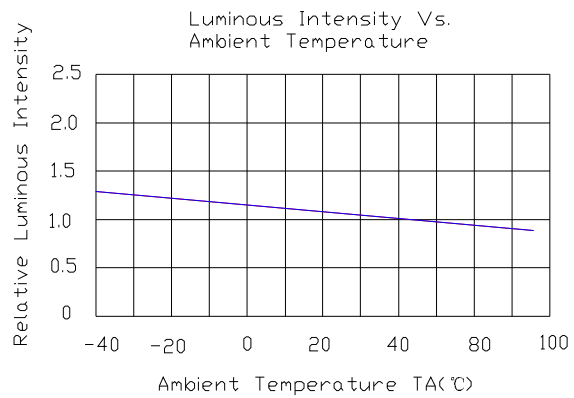
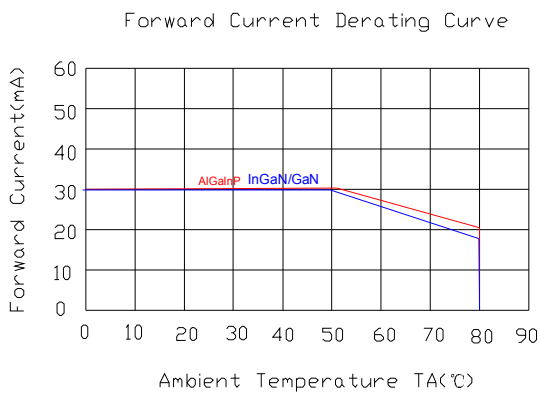
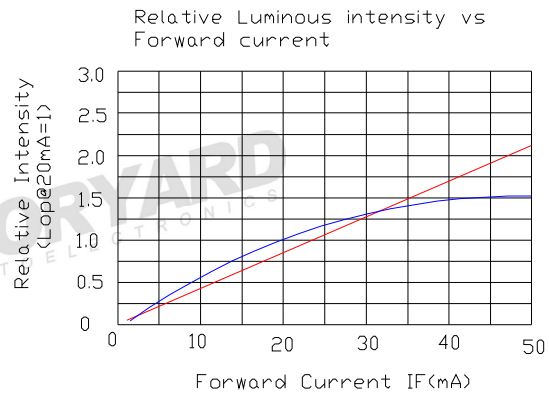
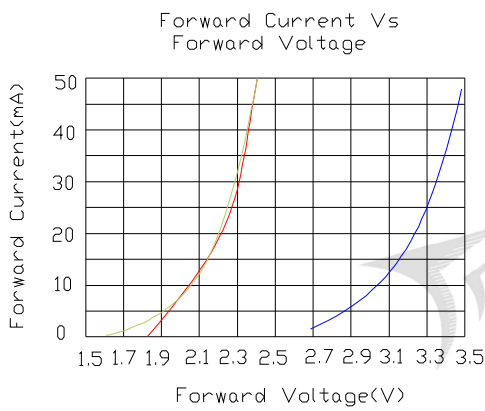
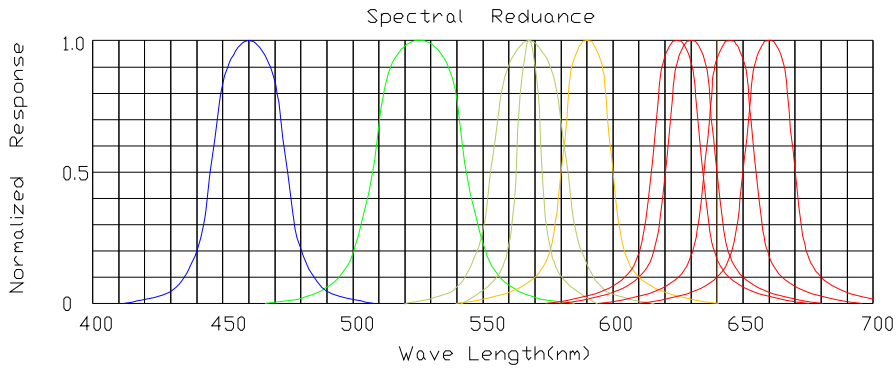

**NOTE:25°C free air temperature unless otherwise specified**

**Radiation pattern-**

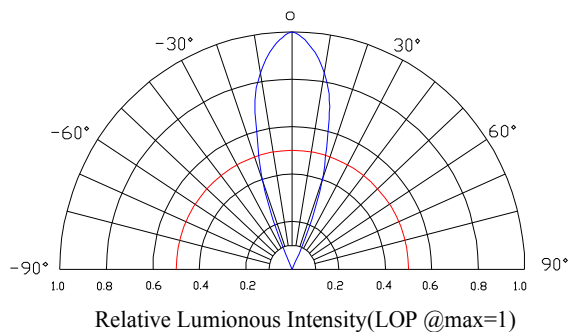

Model No.: FYLS-0603FXXXC

■ Package-

1. Reel Dimension

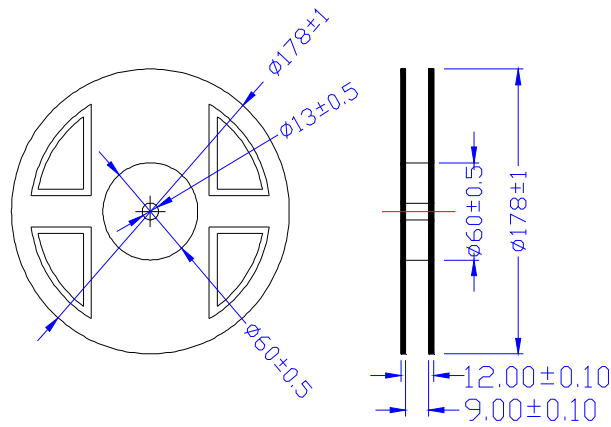

2. Tape Dimension

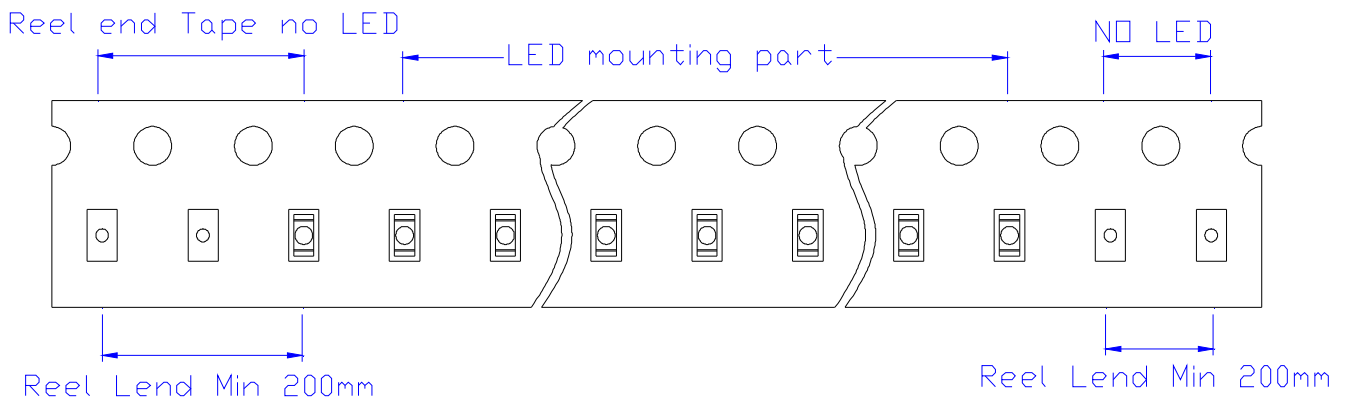
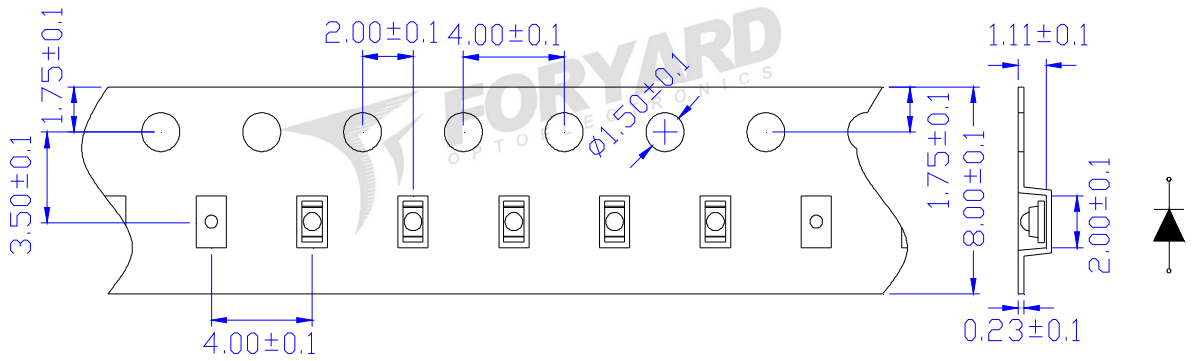



Notice:

1. Tolerance unless mentioned is  $\pm 0.2\text{mm}$

**Model No.: FYLS-0603FXXXC**

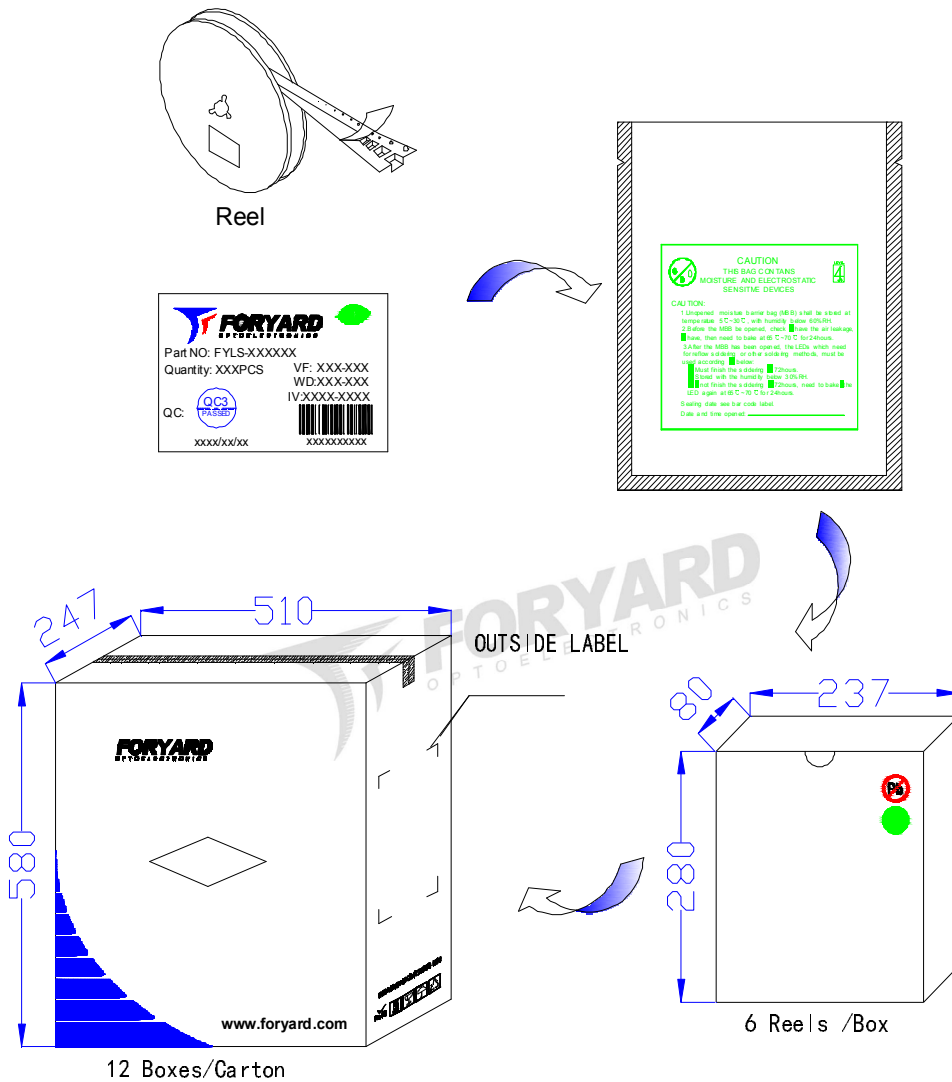

3. Packing Diagram

**LED**  
PN: FYLS-XXXXXXXXXX  
Qty: XXXXX PCS  
Date: XXXX/XX/XX  
GW: XX.XX KG  
NW: XX.XX KG



XXXXXXXXXX

OUTSIDE LABEL

Notice:

- 1.Quantity:4000 PCS/Reel
- 2.The specifications are subject to change without notice. Please contact us for updated information.



**Model No.: FYLS-0603FXXXC**

**■ Soldering Characteristics-**

**● Reflow Soldering**

**● Lead Solder**

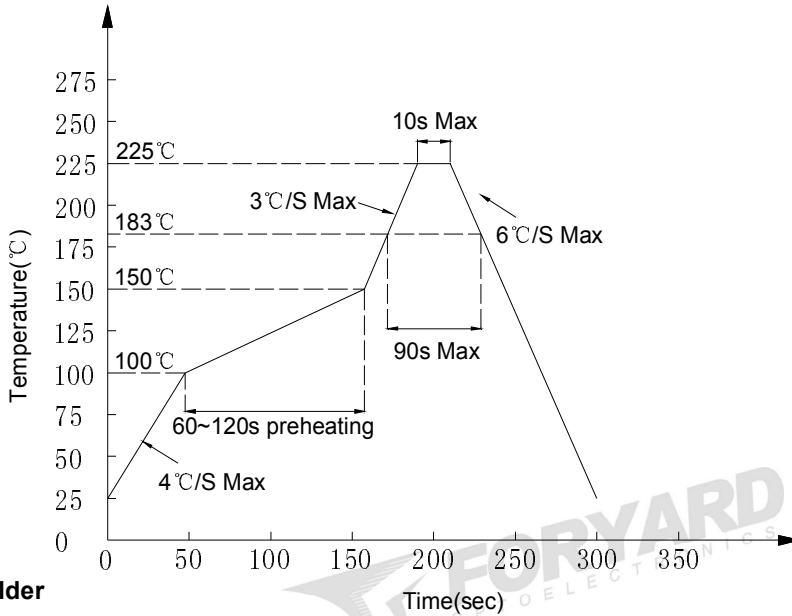

**● Lead-free Solder**

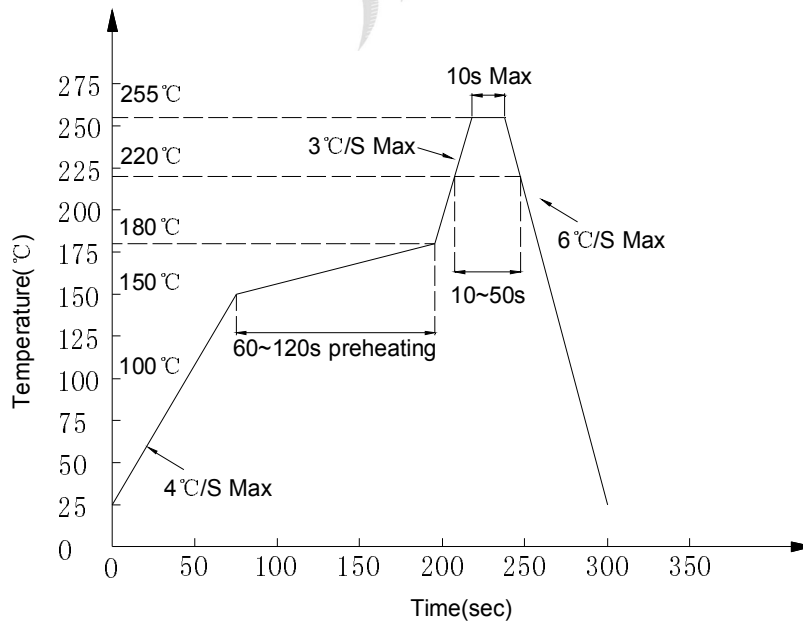

**Notes:**

- 1.Although the recommended soldering conditions are specified in above table, reflow or hand soldering at the lowest possible temperature is desired for the LEDs.
- 2.A rapid-rate process is not recommended for cooling the LEDs down from the peak temperature.
- 3.All temperatures refer to solder Pad.

**● Hand Soldering**

Soldering temperature	300°C Max. (25W Max.)	One time only
Soldering time	5 ±1sec	

**Model No.: FYLS-0603FXXXC**

**■ Handling of Silicone Resin LEDs-**

**● Handling Indications**

When handling the product, do not touch it directly with bare hands as it may contaminate the surface and affect on optical characteristics. In the worst cases, excessive force to the product might result in catastrophic failure due to package damage and/or wire breakage.

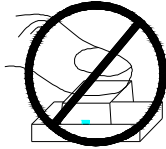

When handling the product with tweezers, LEDs should only be handled from the side and make sure that excessive force is not applied to the resin portion of the product. Failure to comply can cause the resin portion of the product to be cut, chipped, delaminated and/or deformed, and wire to be broken, and thus resulting in catastrophic failure.

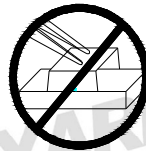
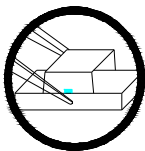

**■ Recommended circuit-**

• In designing a circuit, the current through each LED must not exceed the absolute maximum rating specified for each LED. It is recommended to use Circuit B which regulates the current flowing through each LED. In the meanwhile, when driving LED with a constant voltage in Circuit A, the current through the LEDs may vary due to the variation in forward voltage (VF) of the LEDs. In the worst case, some LED may be subjected to stresses in excess of the absolute maximum rating.

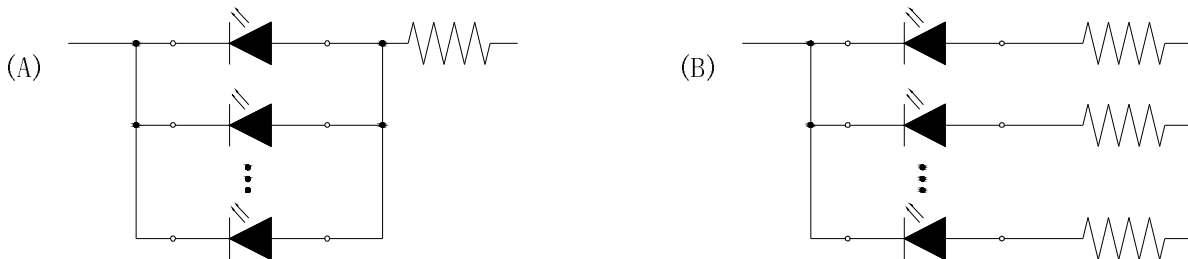

• This product should be operated in forward bias. A driving circuit must be designed so that the product is not subjected to either forward or reverse voltage while it is off. In particular, if a reverse voltage is continuously applied to the product; such operation can cause migration resulting in LED damage.

**■ Storage-**

**● Storage Conditions**

1. Unopened moisture barrier bag (MBB) shall be stored at temperature below 5°C~30°C, with humidity below 60%RH.
2. Before the MBB be opened, check if have the air leakage, if have, then need to bake at 65°C~70°C for 24hours.
3. After the MBB has been opened, the LEDs which need for reflow soldering or other soldering methods, must be used according to below:
  - a: Must finish the soldering in 72hours
  - b: Stored with the humidity below 30%RH
  - c: If not finish the soldering in 72hours, need to bake the LED again at 65°C~70°C for 24hours