

PRODUCT SPECIFICATION

Model No.: FYLS-1206PDB

Features:
<ul style="list-style-type: none"> ■ SMD Type ■ Size (mm):3.20*1.60*1.10 ■ Emitting Color: Photo diode ■ Lens Color: Black. ■ SMT package ■ Suitable for all SMT assembly and soldering method ■ Pb-free Reflow soldering application ■ RoHS Compliant ■ MSL:4

Applications:
<ul style="list-style-type: none"> ■ Mouse ■ Optoelectronic switch ■ Copiers ■ Scanners ■ Amusement machines ■ Surveillance system ■ Wireless communication



CUSTOMER APPROVED SIGNATURES	APPROVED BY	CHECKED BY	PREPARED BY

NINGBO FORYARD OPTOELECTRONICS CO.,LTD.

Add:No. 666 Jinghua Road, Hi-tech Park, Ningbo, Zhejiang, China

Zip:315103

Tel: 0086-574-87933652 87927870 87922206

Fax: 0086-574-87927917

E-mail:Sales@foryard.com (General)

Model No.: FYLS-1206PDB

■ Mechanical Dimensions

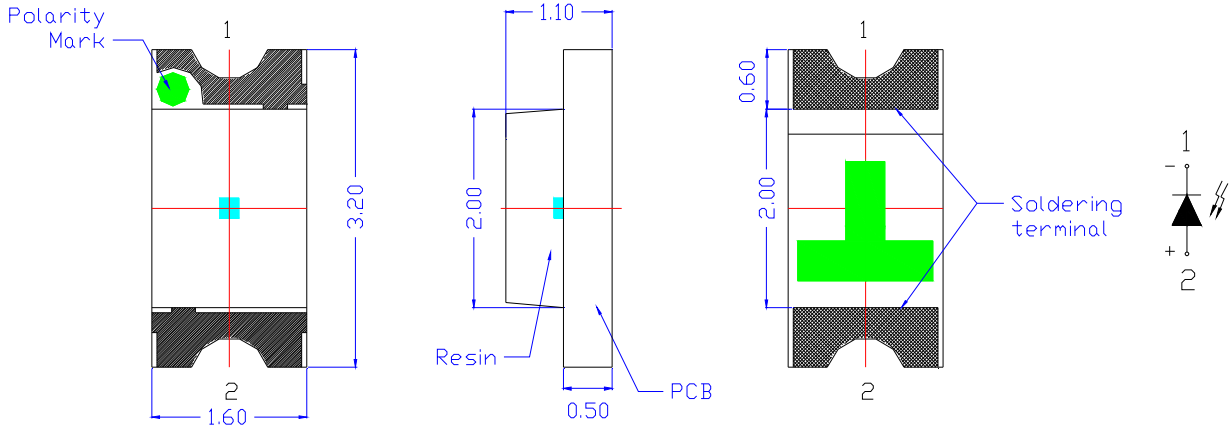

■ Recommend Soldering pad design(unit=mm)

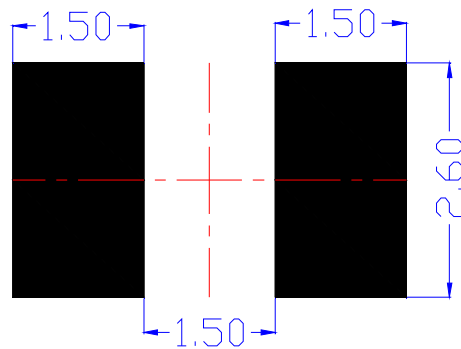

Notes:

1. Dimension in millimeter, tolerance is ± 0.10 .
2. Angle: $\pm 5^\circ$
3. The specifications, characteristics and technical data described in the datasheet are subject to change without prior notice.
4. The drawing is different from the actual one, please refer to the sample.

Model No.: FYLS-1206PDB

■ Absolute Maximun Ratings(Ta=25°C)

Parameter	Symbol	Ratings	Unit
Power Dissipation (or below) 25 Free Air Temperature	PD	150	mW
Reverse Voltage	V _R	32	V
Operating Temperature Range	Topr	-25~ +85	°C
Storage Temperature Range	Tstg	-40~ +100	°C
Soldering Temperature	Tsol	Reflow soldering : 260°C , 5s	
		Hand soldering : 300°C , 3s	

■ Typical Electrical &Optical Charcteristics(Ta=25°C)

Parameter	Symbol	Test Condition	Min.	Typ.	Max.	Unit
Open-Circuit Voltage	VOC	Ee=5mW/cm ² λp=940nm	---	0.3	---	V
Short- Circuit Current	ISC	Ee=1mW/cm ² λp=940nm	---	6.5	---	μA
Reverse Light Current	IL	Ee=1mW/cm ² λp=875nm V _R =5V	4	7	---	μA
		Ee=1mW/cm ² λp=940nm V _R =5V	---	7	---	μA
Reverse Dark Current	ID	Ee=0mW/cm ² V _R =5V	---	---	20	nA
Reverse Breakdown Voltage	BVR	Ee=0mW/cm ² I _R =100 μa	33	170	---	V
Forward Voltage	VF	I _F =20mA	0.5	---	1.3	V
Rise Time	t _r	V _R =10V R _L =1000Ω	---	50	---	nS
Fall Time	t _f	V _R =10V R _L =1000Ω	---	50	---	nS
Total Capacitance	Ct	Ee=0mW/cm ² V _R =3V f=1MHZ	---	505	---	pF
Rang Of Spectral Bandwidth	λ _{0.5}	---	420	---	1100	nm
Wavelength of Peak Sensitivity	λp	---	---	940	---	nm
View Angle	2θ _{1/2}	V _R =5V	---	120	---	Deg

■ Material

Item	Reflector	Wire	Encapsulate	Chip
Material	/	Gold	Epoxy	AlGaAs/Si

Note:

- 1.Luminous Intensity is based on the Foryard standards.
- 2.Pay attention about static for InGaN

Model No.: FYLS-1206PDB

Electrical-Optical Characteristics-

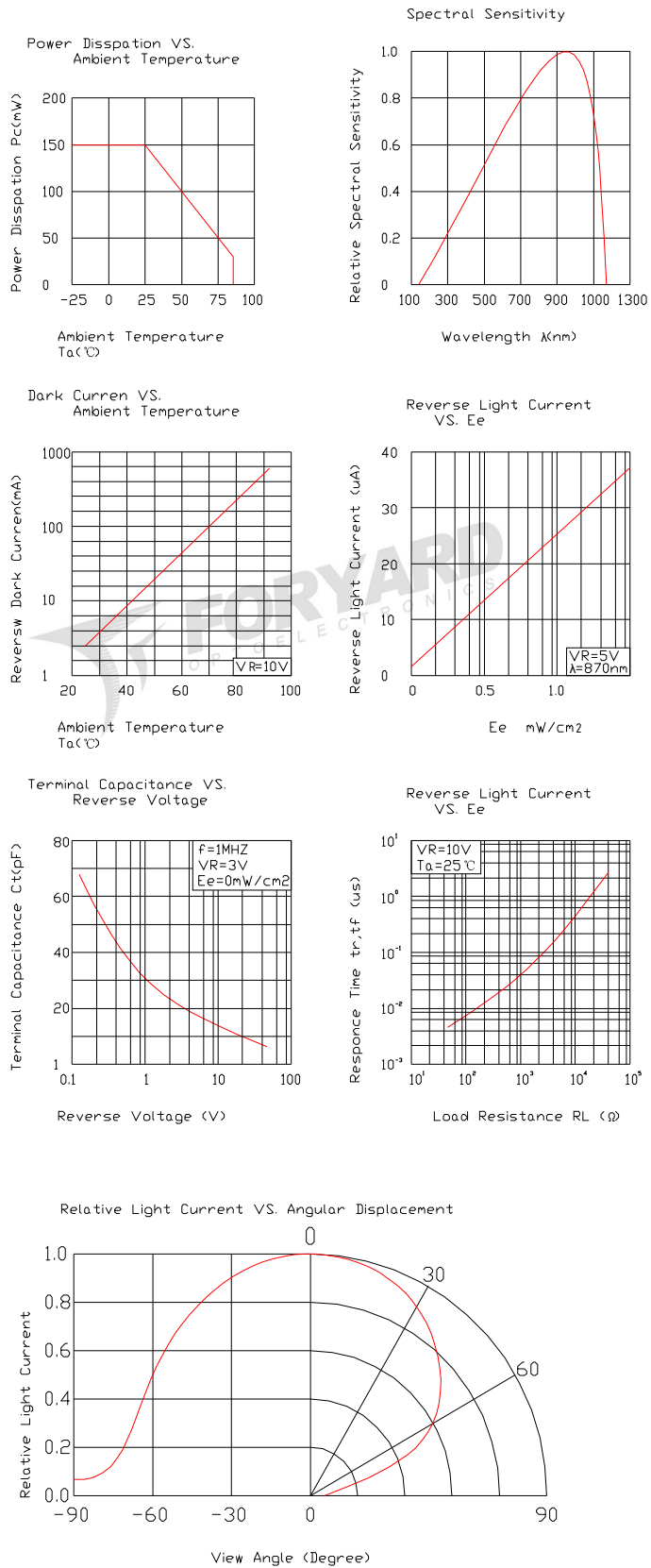

NOTE:25°C free air temperature unless otherwise specified

Model No.: FYLS-1206PDB

■ **Package-**

1. Reel Dimension

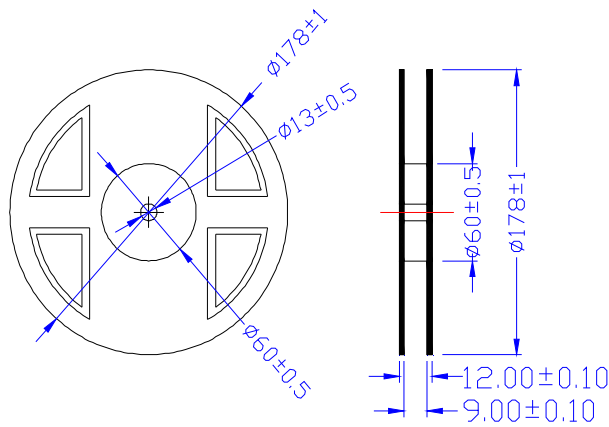

2. Tape Dimension

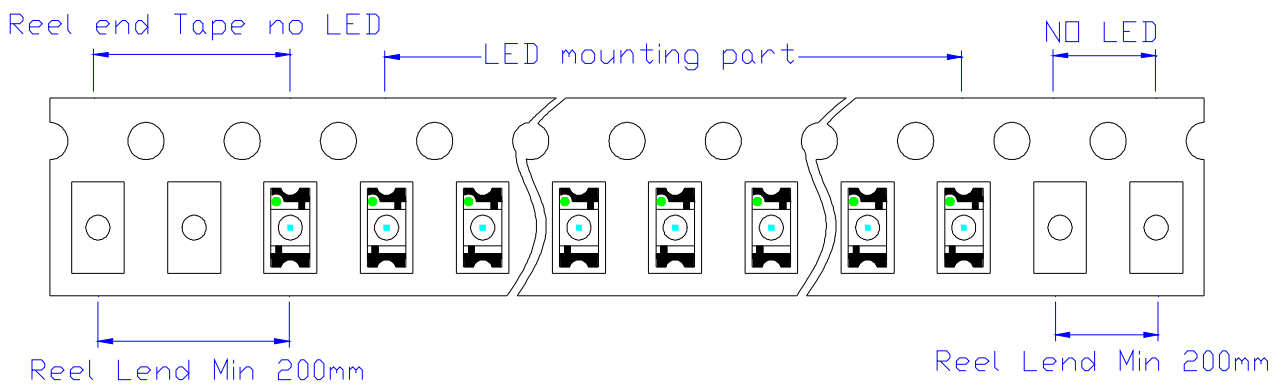
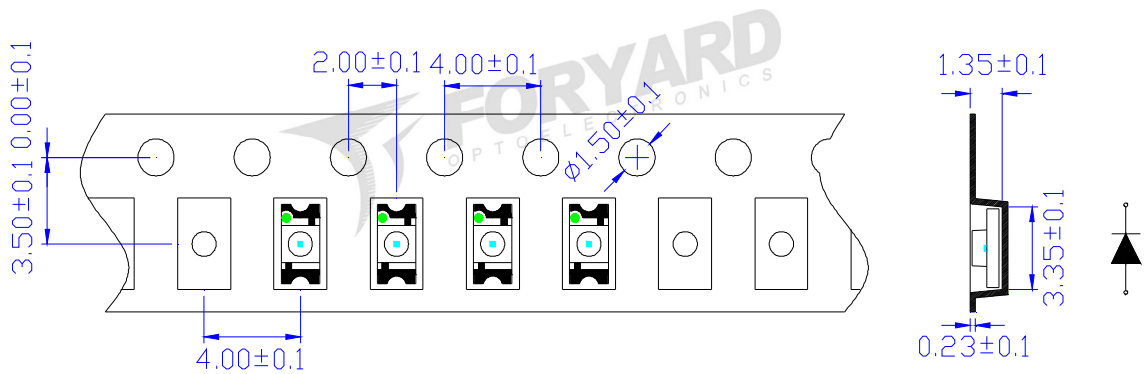



Notice:

1. Tolerance unless mentioned is $\pm 0.2\text{mm}$

Model No.: FYLS-1206PDB

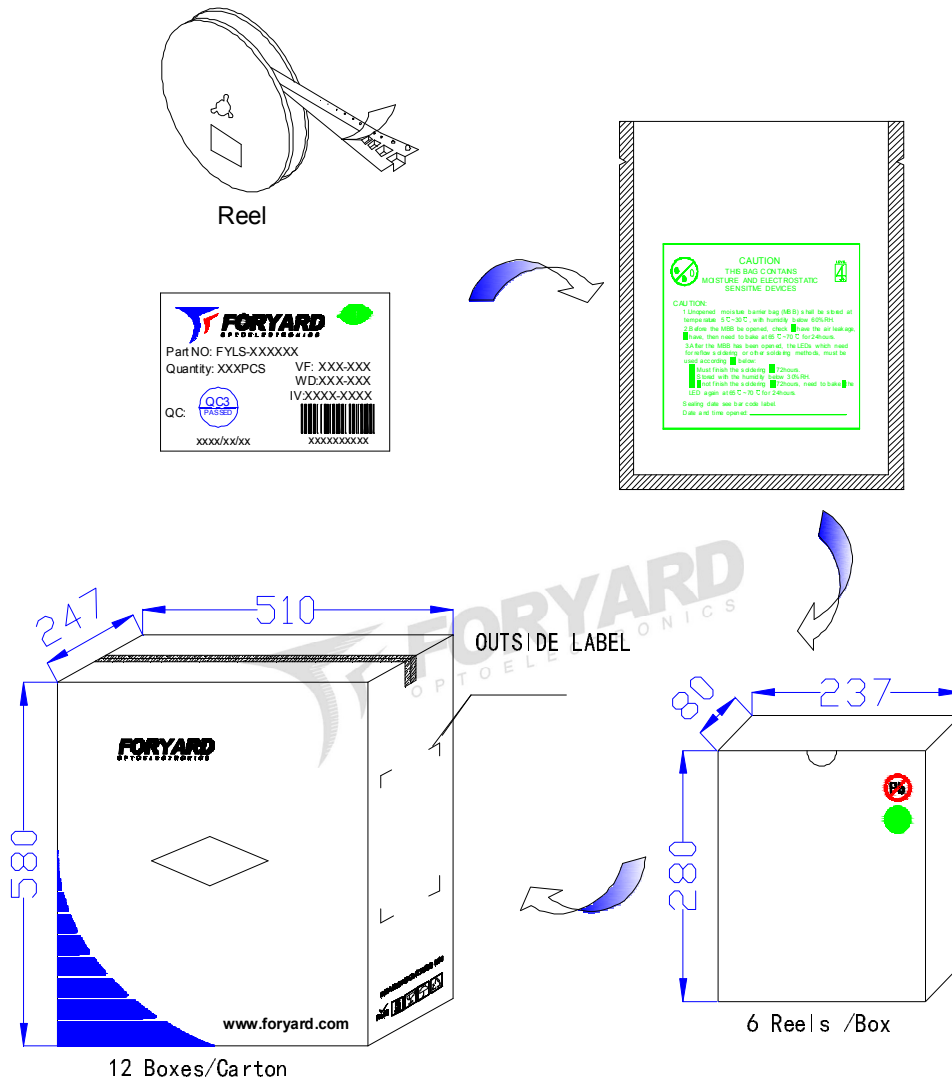

3. Packing Diagram

LED
PN: FYLS-XXXXXXXXXX
Qty: XXXXX PCS
Date: XXXX/XX/XX
GW: XX.XX KG
NW: XX.XX KG



XXXXXXXXXX

OUTSIDE LABEL

Notice:

- 1.Quantity:3000 PCS/Reel
- 2.The specifications are subject to change without notice. Please contact us for updated information.

Model No.: FYLS-1206PDB

■ Soldering Characteristics-

● Reflow Soldering

● Lead Solder

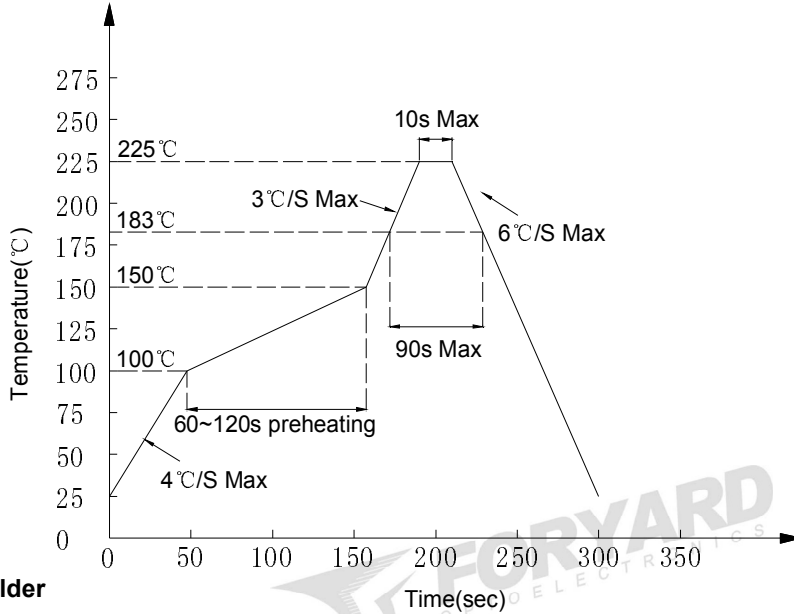

● Lead-free Solder

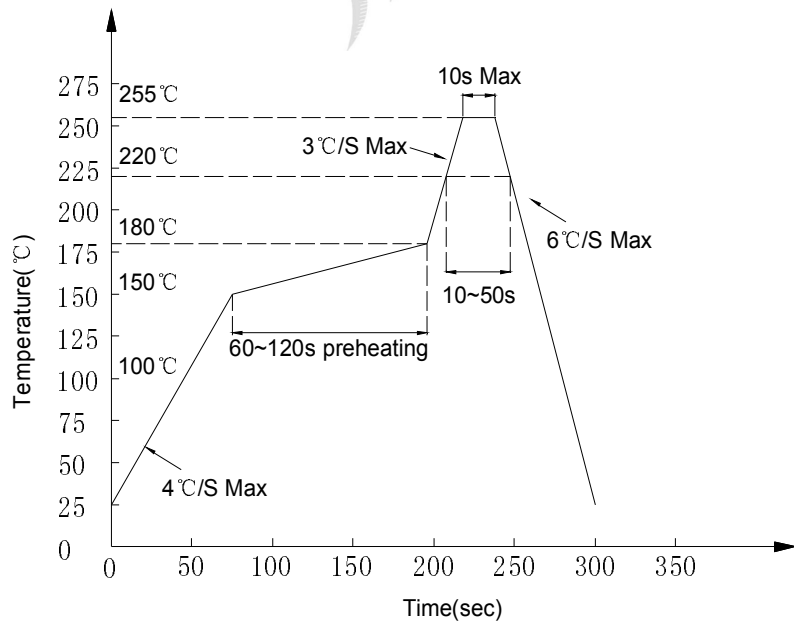

Notes:

1. Although the recommended soldering conditions are specified in above table, reflow or hand soldering at the lowest possible temperature is desired for the LEDs.
2. A rapid-rate process is not recommended for cooling the LEDs down from the peak temperature.
3. All temperatures refer to solder Pad.

● Hand Soldering

Soldering temperature	300°C Max. (25W Max.)	One time only
Soldering time	3 ±1sec	

Model No.: FYLS-1206PDB

■ Handling of Silicone Resin LEDs-

● Handling Indications

When handling the product, do not touch it directly with bare hands as it may contaminate the surface and affect on optical characteristics. In the worst cases, excessive force to the product might result in catastrophic failure due to package damage and/or wire breakage.

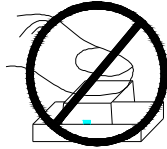

When handling the product with tweezers, LEDs should only be handled from the side and make sure that excessive force is not applied to the resin portion of the product. Failure to comply can cause the resin portion of the product to be cut, chipped, delaminated and/or deformed, and wire to be broken, and thus resulting in catastrophic failure.

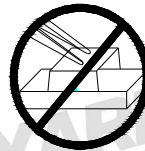
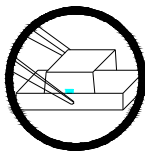

■ Recommended circuit-

• In designing a circuit, the current through each LED must not exceed the absolute maximum rating specified for each LED. It is recommended to use Circuit B which regulates the current flowing through each LED. In the meanwhile, when driving LEDs with a constant voltage in Circuit A, the current through the LEDs may vary due to the variation in forward voltage (VF) of the LEDs. In the worst case, some LED may be subjected to stresses in excess of the absolute maximum rating.

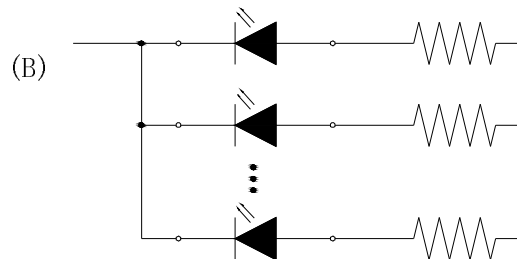
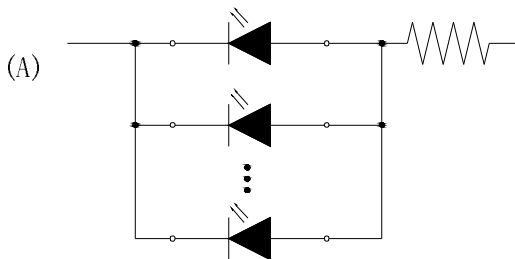

• This product should be operated in forward bias. A driving circuit must be designed so that the product is not subjected to either forward or reverse voltage while it is off. In particular, if a reverse voltage is continuously applied to the product; such operation can cause migration resulting in LED damage.

■ Storage-

● Storage Conditions

1. Unopened moisture barrier bag (MBB) shall be stored at temperature below 5°C~30°C, with humidity below 60%RH.
2. Before the MBB be opened, check if have the air leakage, if have, then need to bake at 65°C~70°C for 24hours.
3. After the MBB has been opened, the LEDs which need for reflow soldering or other soldering methods, must be used according to below:
 - a: Must finish the soldering in 72hours
 - b: Stored with the humidity below 30%RH
 - c: If not finish the soldering in 72hours, need to bake the LED again at 65°C~70°C for 24hours