

PRODUCT SPECIFICATION

Model No.: FYLP-1W-XXB-A

Features:
<ul style="list-style-type: none"> ■ SMD Type ■ Size (mm):20.00*20.78*8.00 ■ Lens Type: Water clear. ■ Viewing Angle(2θ^{1/2}):120° ■ SMT package ■ RoHS Compliant ■ MSL:6

Applications:
<ul style="list-style-type: none"> ■ Light Strips ■ LCD Backlight ■ Decorative lighting ■ Indicators ■ Interior automotive ■ Illuminations ■ Mobile Phones



CUSTOMER APPROVED SIGNATURES	APPROVED BY	CHECKED BY	PREPARED BY

NINGBO FORYARD OPTOELECTRONICS CO.,LTD.

Add:No. 666 Jinghua Road, Hi-tech Park, Ningbo, Zhejiang, China

Zip:315103

Tel: 0086-574-87933652 87927870 87922206

Fax: 0086-574-87927917

E-mail:Sales@foryard.com (General)

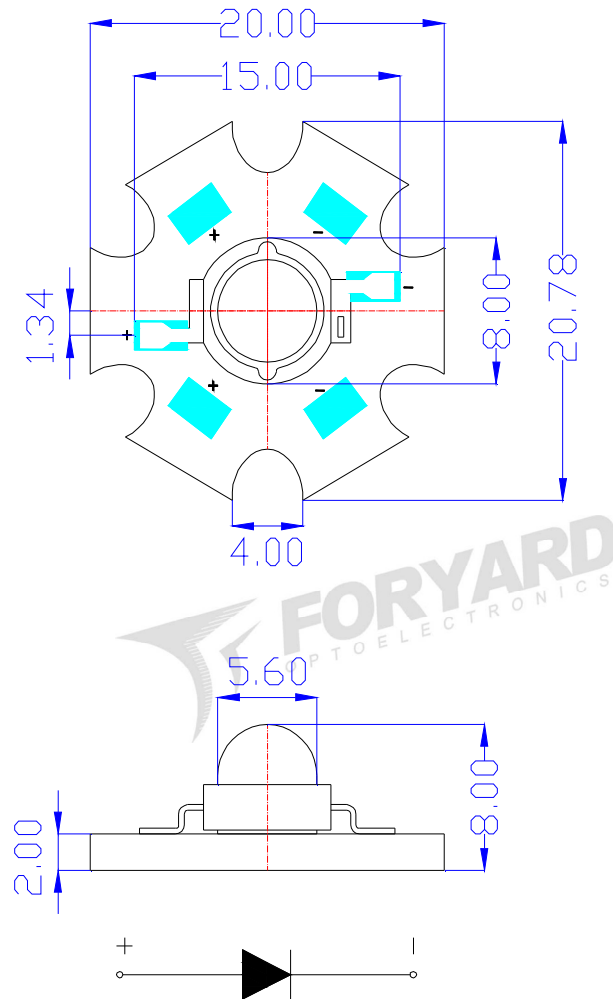
Model No.: FYLP-1W-XXB-A
■ Mechanical Dimensions

Notes:

1. Dimension in millimeter, tolerance is ± 0.10 .
2. Angle: $\pm 5^\circ$
3. The specifications, characteristics and technical data described in the datasheet are subject to change without prior notice.
4. The drawing is different from the actual one, please refer to the sample.

Model No.: FYLP-1W-XXB-A

Absolute maximum ratings; Ta=25°C

Parameter	Symbol	MAX.				Unit
		AlGaInP	AlGaInP	InGaN/GaN	InGaN/GaN	
		Red	Yellow	Purea Gree	Blue	
Forward DC Current	IF	350	350	350	350	mA
Peak Forward Current*	IFP	350	350	350	350	mA
Power Dissipation	PD	1000	1000	1000	1000	mW
Reverse Voltage	VR	5				V
Reverse Current (VR=5V)	IR	10				u A
Operating Temperature Range	Topr	-20~ +75				°C
Storage Temperature Range	Tstg	-40~ +100				°C
Soldering temperature	Tsol	300°C Max.(25W Max.);5 ±1sec				

*1/10 Duty Cycle, 0.1ms Pulse Width

Electrical-Optical Characteristics

● Color Code & Chip Characteristics:(Test Condition:IF=350mA)

(Ta=25°C)

Model No.:	Emitting Color	Dice Material	Peak Wave	Dominant Wave			Spectral Line	Forward Voltage(VF)			Luminous Flux (Φ)		
			Length(λP) nm	Length(λd) nm			halfwidth (Δλ1/2) nm	Unit:V			Unit:Lm		
				Min.	Typ.	Max.		Min.	Typ.	Max.	Min.	Typ.	Max.
Ultra brightness													
FYLP-1W-URB-A	Ultra Red	AlGaInP	630	620	623	627	20	1.80	2.40	2.80	30	35	40
FYLP-1W-UYB-A	Ultra Yellow	AlGaInP	593	586	592	596	20	1.80	2.40	2.80	30	35	40
FYLP-1W-PGB-A	Purea Green	InGaN/GaN	520	514	521.5	529	36	2.80	3.40	4.00	70	75	80
FYLP-1W-UBB-A	Ultra Blue	InGaN/GaN	468	460	465	471	30	2.80	3.40	4.00	15	20	25

Material

Item	Reflector	Wire	Encapsulate
Material	PPA	Gold	Silicone

Note:

- 1.Luminous Intensity is based on the Foryard standards.
- 2.Pay attention about static for InGaN

Model No.: FYLP-1W-XXB-A

■ The Luminous Flux Grade of Products(Unit: Lm) ;Test Condition: If=350mA,Ta=25℃

B01	B02	B03	B04	B05	B06	B07	B08	B09	B10	B11	B12
3.00	4.00	5.00	6.00	7.00	8.00	9.00	10.00	11.00	12.00	13.00	14.00
4.00	5.00	6.00	7.00	8.00	9.00	10.00	11.00	12.00	13.00	14.00	15.00
B13	B14	B15	B16	B17	B18	B19	B20	B21	B22	B23	B24
15.00	16.00	17.00	18.00	19.00	20.00	22.00	24.00	26.00	28.00	30.00	32.00
16.00	17.00	18.00	19.00	20.00	22.00	24.00	26.00	28.00	30.00	32.00	34.00
B25	B26	B27	B28	B29	B30	B31	B32	B33	B34	B35	B36
34.00	36.00	38.00	40.00	42.00	44.00	46.00	48.00	50.00	55.00	60.00	65.00
36.00	38.00	40.00	42.00	44.00	46.00	48.00	50.00	55.00	60.00	65.00	70.00
B37	B38	B39	B40	B41	B42	B43	B44	B45	B46	B47	B48
70.00	75.00	80.00	85.00	90.00	95.00	100.00	110.00	120.00	130.00	140.00	150.00
75.00	80.00	85.00	90.00	95.00	100.00	110.00	120.00	130.00	140.00	150.00	160.00
B49	B50	B51	B52	B53	B54	B55	B56				
160.00	170.00	180.00	200.00	220.00	240.00	260.00	280.00				
170.00	180.00	200.00	220.00	240.00	260.00	280.00	300.00				

Tolerance of measurement of luminous intensity is ±15%

■ Forward Voltage Grade of Products (Unit: V); Test Condition: If=350mA,Ta=25℃

1	2	3	4	5	6	7	8	9	10	11	12
1.60	1.80	2.00	2.20	2.40	2.60	2.80	3.00	3.20	3.40	3.60	3.80
1.80	2.00	2.20	2.40	2.60	2.80	3.00	3.20	3.40	3.60	3.80	4.00

Tolerance of measurement of forward voltage is ±0.1V

Model No.: FYLP-1W-XXB-A

■ Dominate Wavelength Guide (Unit: nm) @IF=350mA, Ta=25°C

Red/Ultra Red			
UR			
0	1	2	3
620.00	623.00	627.00	632.00
623.00	627.00	632.00	640.00

Yellow /Ultra Yellow					
Y/UY					
1	2	3	4	5	6
584.00	586.00	588.00	590.00	592.00	594.00
586.00	588.00	590.00	592.00	594.00	596.00

Purea Green									
PG									
1	2	3	4	5	6	7	8	9	A
511.50	514.00	516.50	519.00	521.50	524.00	526.50	529.00	531.50	534.00
514.00	516.50	519.00	521.50	524.00	526.50	529.00	531.50	534.00	536.50

Ultra Blue					
UB					
0	1	2	3	4	5
460.00	463.50	466.00	468.50	471.00	473.50
463.50	466.00	468.50	471.00	473.50	476.00

Tolerance for each Dominate Wavelength bin is ±1nm

Model No.: FYLP-1W-XXB-A

Electrical-Optical Characteristics-

Fig.1-Relative luminous Intensity vs. Forward Current

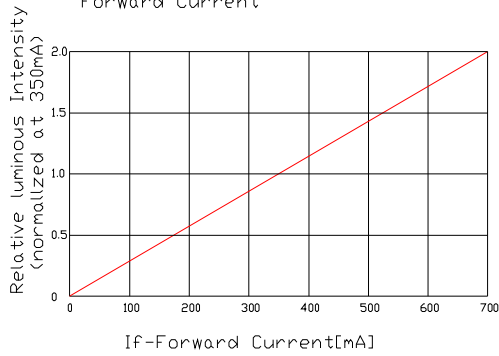

Fig.2-Forward Current vs. Forward Voltage

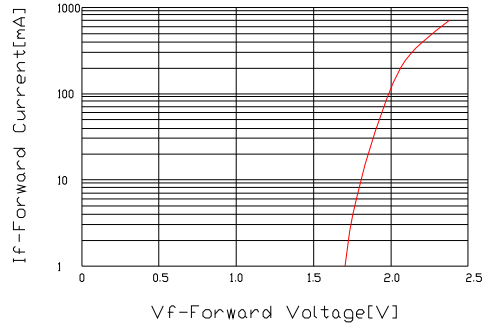

Fig.3-Relative Intensity(@350mA) vs. Ambient Temperature

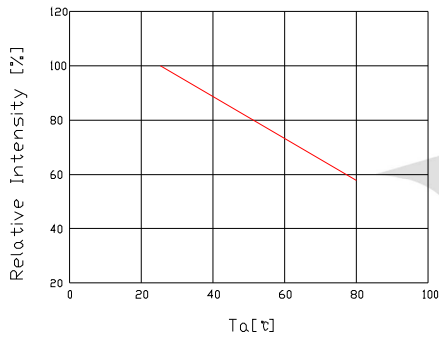

Fig.4-Forward Voltage(@350mA) vs. Ambient Temperature

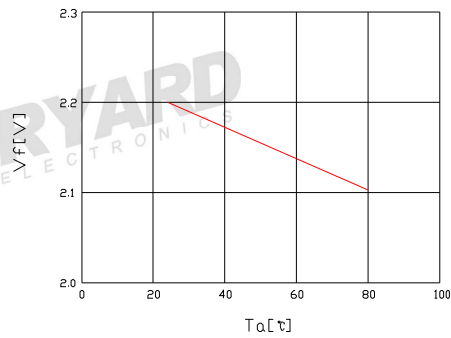

Fig.5-Dominant Wavelength(@350mA) vs. Ambient Temperature

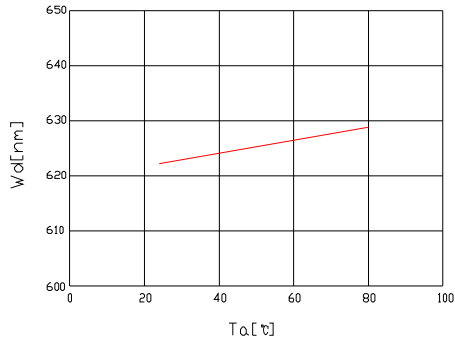
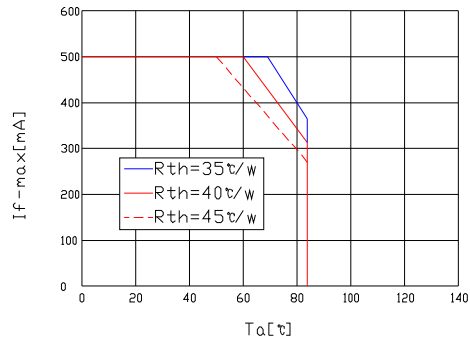

Fig.6-Maximum Driving Forward DC Current vs. Ambient Temperature (De-rating based on Tj max.=125°C)



NOTE:25°C free air temperature unless otherwise specified

Model No.: FYLP-1W-XXB-A
Electrical-Optical Characteristics-

Fig.1-Relative luminous Intensity vs. Forward Current

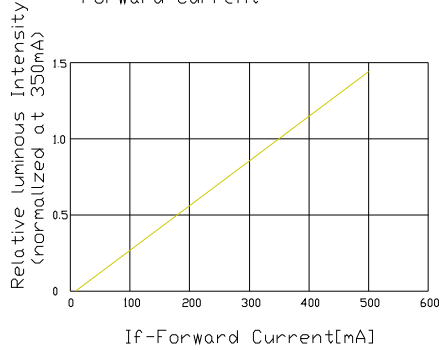

Fig.2-Forward Current vs. Forward Voltage

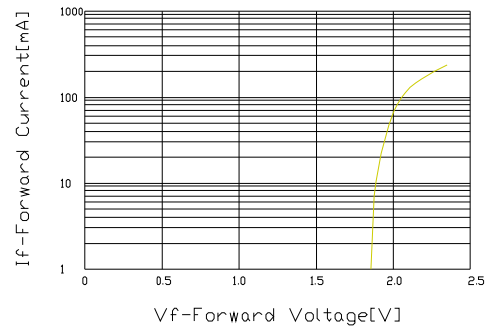

Fig.3-Relative Intensity(@350mA) vs. Ambient Temperature

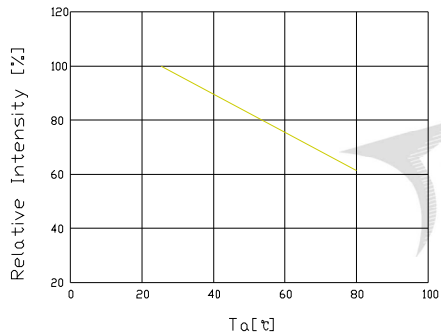

Fig.4-Forward Voltage(@350mA) vs. Ambient Temperature

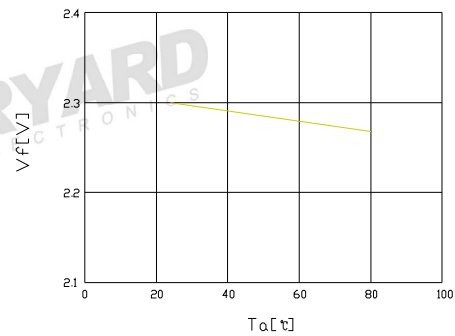

Fig.5-Dominant Wavelength(@350mA) vs. Ambient Temperature

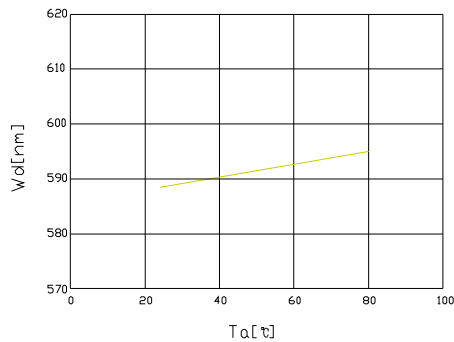
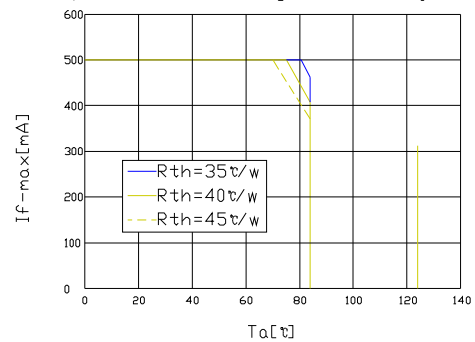

Fig.6-Maximum Driving Forward DC Current vs. Ambient Temperature (De-rating based on Tj max.=125°C)



NOTE:25°C free air temperature unless otherwise specified

Model No.: FYLP-1W-XXB-A

Electrical-Optical Characteristics-

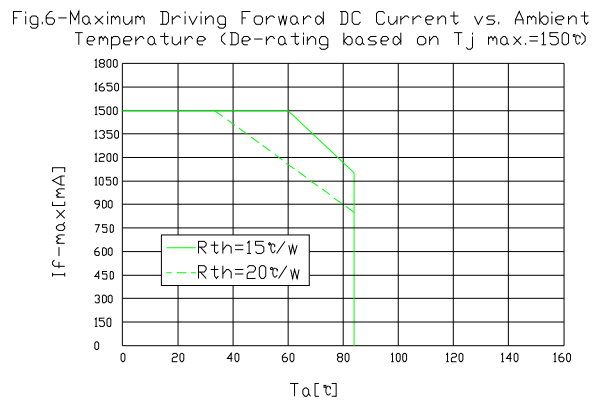
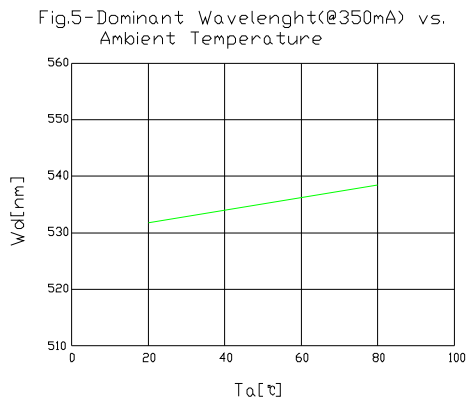
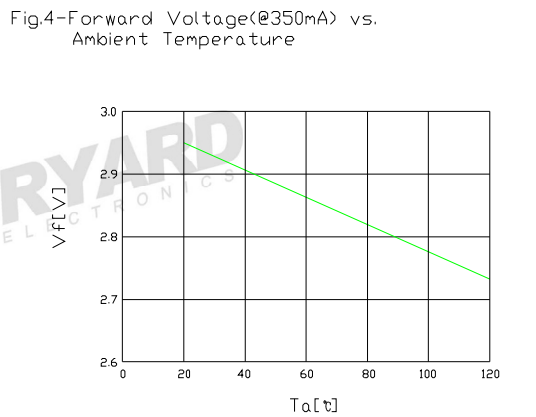
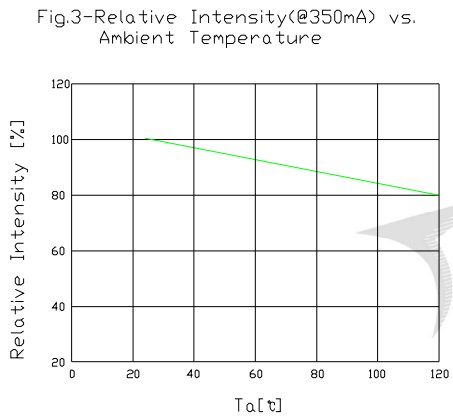
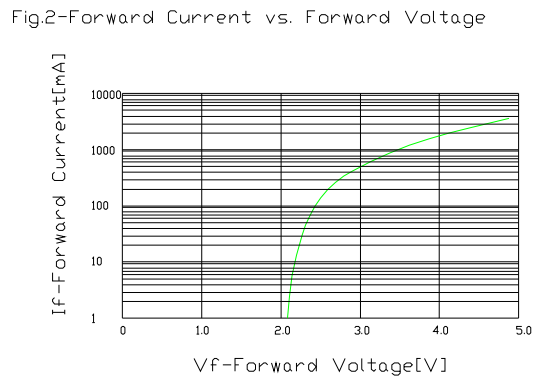
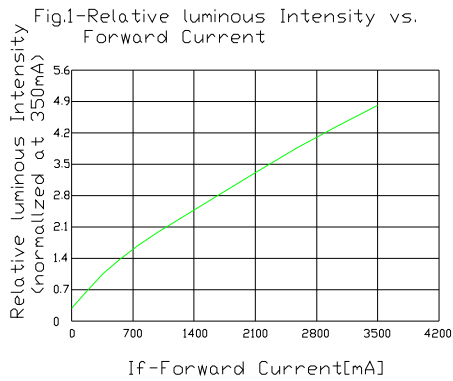

NOTE:25°C free air temperature unless otherwise specified

Model No.: FYLP-1W-XXB-A

Electrical-Optical Characteristics-

Fig.1-Relative luminous Intensity vs. Forward Current

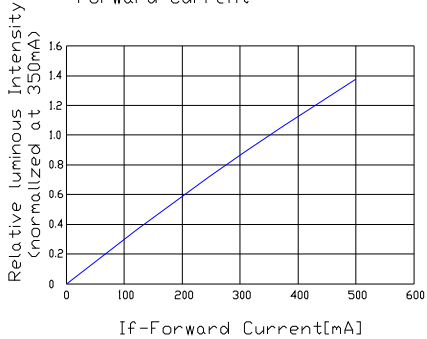

Fig.2-Forward Current vs. Forward Voltage

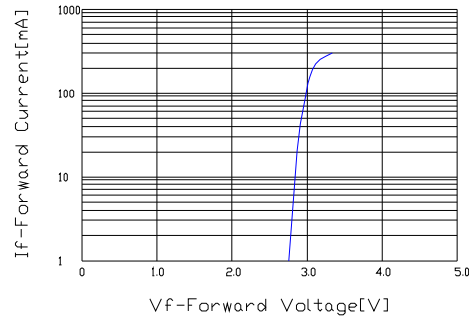

Fig.3-Relative Intensity(@350mA) vs. Ambient Temperature

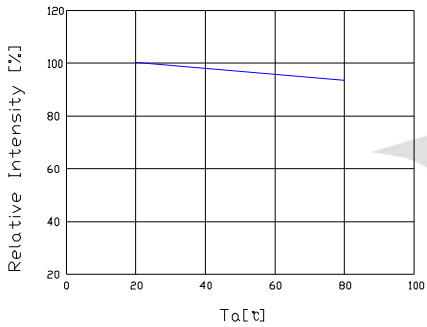

Fig.4-Forward Voltage(@350mA) vs. Ambient Temperature

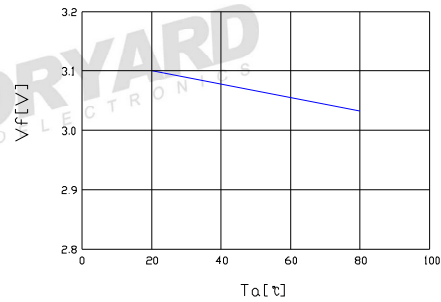

Fig.5-Dominant Wavelength(@350mA) vs. Ambient Temperature

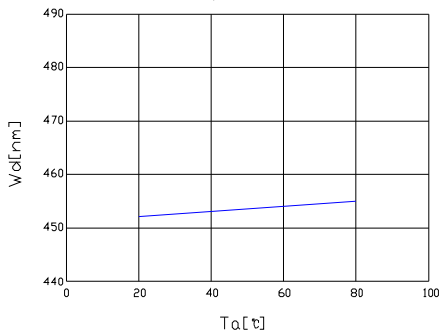
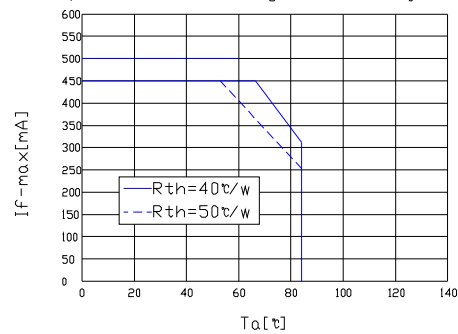
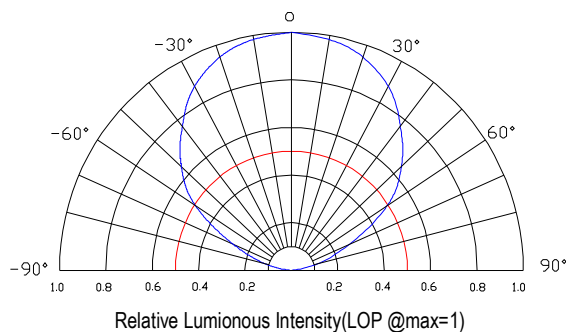

Fig.6-Maximum Driving Forward DC Current vs. Ambient Temperature (De-rating based on Tj max.=125t)



NOTE:25°C free air temperature unless otherwise specified

Radiation pattern-



Model No.: FYLP-1W-XXB-A

Package-

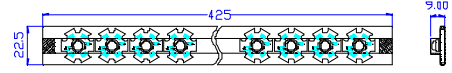
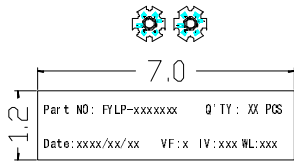

20PCS/Tube

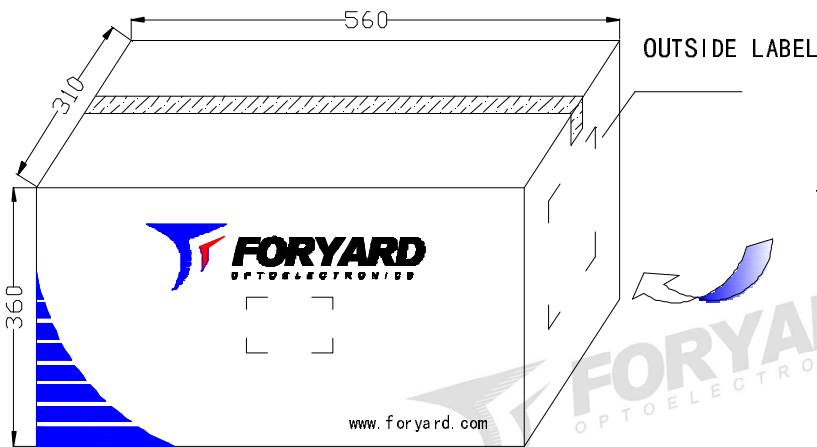

6Box/Carton

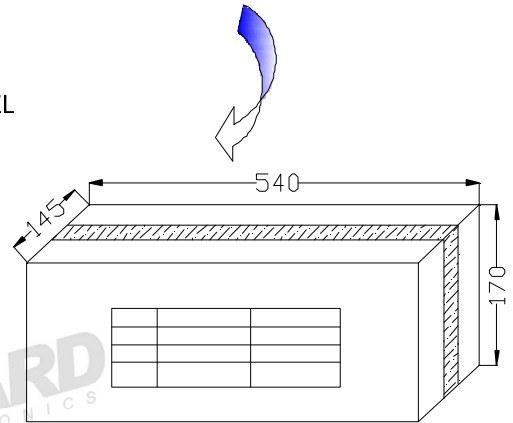

108 Tube/Box



LED

PN: FYLP-XX-XXX-X

Qty: XXXXX PCS

Date: xxxx/xx/xx

GW: XX KG QC: PASS
QC

NW: XX KG



XXXXXXXXXX



OUTSIDE LABEL

Notice:

- 1.Quantity:20 PCS/Tube
- 2.Tolerance unless mentioned is $\pm 0.2\text{mm}$
- 3.The specifications are subject to change without notice. Please contact us for updated information.

Model No.: FYLP-1W-XXB-A

■ Handling of Silicone Resin LEDs-

● Handling Indications

When handling the product, do not touch it directly with bare hands as it may contaminate the surface and affect on optical characteristics. In the worst cases, excessive force to the product might result in catastrophic failure due to package damage and/or wire breakage.

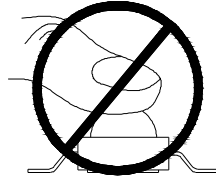

When handling the product with tweezers, LEDs should only be handled from the side and make sure that excessive force is not applied to the resin portion of the product. Failure to comply can cause the resin portion of the product to be cut, chipped, delaminated and/or deformed, and wire to be broken, and thus resulting in catastrophic failure.

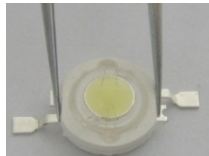

OK

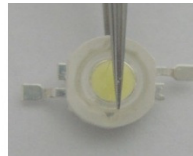

NG

■ Recommended circuit-

• In designing a circuit, the current through each LED must not exceed the absolute maximum rating specified for each LED. It is recommended to use Circuit B which regulates the current flowing through each LED. In the meanwhile, when driving LEDs with a constant voltage in Circuit A, the current through the LEDs may vary due to the variation in forward voltage (VF) of the LEDs. In the worst case, some LED may be subjected to stresses in excess of the absolute maximum rating.

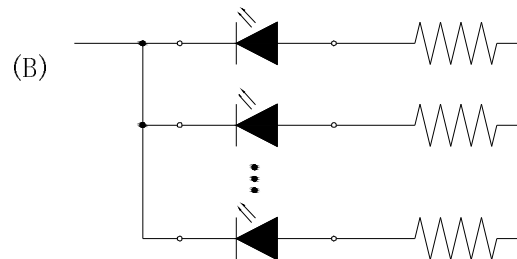
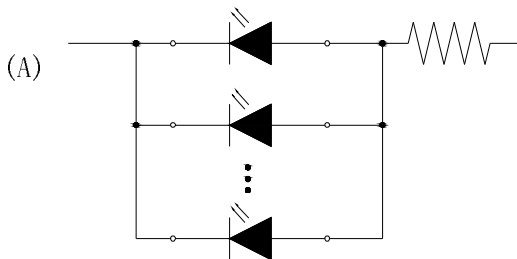

• This product should be operated in forward bias. A driving circuit must be designed so that the product is not subjected to either forward or reverse voltage while it is off. In particular, if a reverse voltage is continuously applied to the product; such operation can cause migration resulting in LED damage.

■ Storage-

● Storage Conditions

1. Unopened moisture barrier bag (MBB) shall be stored at temperature below 5°C~30°C, with humidity below 60%RH.
2. Before the MBB be opened, check if have the air leakage, if have, then need to bake at 65°C~70°C for 24hours.
3. After the MBB has been opened, the LEDs which need for reflow soldering or other soldering methods, must be used according to below:
 - a: Must finish the soldering in 12hours
 - b: Stored with the humidity below 30%RH
 - c: If not finish the soldering in 12hours, need to bake the LED again at 65°C~70°C for 24hours